

MegaTron XT



Touch Screen Controller

Product Manual



Important Safety Instructions

Read all warnings and instructions in this manual.
Save all instructions.



Advantage Europe

The European branch of Advantage Controls

Support: info@advantage-eu.com

Website: www.advantage-eu.com

Vorsterweg 26
3980 Tessenderlo-Ham

Belgium



04/2026

MegaTronXT Touch Screen Controller Instruction & Maintenance Manual Table of Contents

Contents	Page
I. Introduction.....	3
Model Numbering.....	3
Description of Unit.....	3
Control Functions.....	4
Chemical Feed Timers.....	4
II. Intended Use.....	5
Mechanical Specifications.....	5
Icon Definitions.....	5
III. Installation.....	5
Electrical Wiring Information.....	5
Mounting Location Information.....	6
Back Pane and System Card Connections.....	7
Wiring Diagrams.....	8
Electrode Installation.....	10
A. Cooling Tower.....	10
B. Boiler.....	12
IV. Front Panel.....	14
V. System Operation Overview.....	14
Start-Up.....	14
Calibration.....	14
VI. Menu Navigation.....	16
VII. Maintenance.....	33
Electrode Cleaning Procedures.....	33
VIII. Warranty & 30 Day Billing Memo Policy.....	34
Additional Wiring Diagrams.....	35

I. Introduction

The MegaTronXT microprocessor-based controllers are programmable through a front panel touch screen and can be configured to control a wide range of digital and analog inputs. Your particular unit's functions can be determined by comparing the units model number to the Model Numbering table listed below.

Model Numbering

MegaTronXT units have several base system control functions and unit optional features. Your unit may be supplied with one or more of the features described in this manual. To determine what features apply to your unit check the model number label located on the controller enclosure.

Build a ModelX T C P R F E - N8 V Z1

Step 1 system card functions

Conductivity	
B	Boiler with BE-34BC
C	Tower with TE-4A
C12	Low range with AL-4ASS

Misc Conductivity	
M	General range with DI-4A
M4	General range with TE-4A

pH	
P	Single set point with TPE-21
Q	Dual set point with TPE-21

ORP	
R	Standard with TOE-21

Feed Timers	
F	Five selectable

Flow Assembly	
E	Float style flow switch, PVC
E6	Flow input only

Step 2 whole unit options
 XT standard features include 5 control relays with prewired USA cords and WebAdvantage communications. List any desired options in alphabetical order.

Power Cord Options		mA In/Out Signals	
100-230 VAC except A22		16 signals max	
A	All 1/2" FNPT conduit connections	N4	(4) mA inputs
A2	Class F cord, no relay pigtailed, CE mark	N8	(8) mA inputs
A3	Liquid tight only, CE mark	N12	(12) mA inputs and (4) outputs
A5	USA power cord, no relay pigtailed	N16	(16) mA inputs and (0) outputs
A7	Class I cord, no relay pigtailed, CE mark	O4	(4) mA isolated outputs
A8	Prewired USA cord, 1/2" conduit relay	O8	(8) mA isolated outputs
A22	24 VDC power instead of 100-230 VAC		

Communication Options	
WebAdv standard	
H2	Adds Wi-fi module to built-in WebAdv coms
H3	No active WebAdvantage communications
H25	Dual network w/ Modbus TCP/IP read/write
H26	Dual network w/ BACnet TCP/IP read/write

Relay Options	
(2.5 amp each)	
K1	(5) relay card not connected to power
K2	(5) relay card all set for dry contact
K3	No control relays
K7	(7) powered relays and (3) dry contact relays

Accessories	
V	24 VDC power for external signals
W	(5) additional flowmeter pulse inputs
Y	ETL Agency Listings (USA, CSA)
Z	Black display cover
Z1	Clear display cover

Tower / general range conductivity sensors include a temperature reading. Additional sensor types are available. Consult dealer for additional options.

Notice: Your unit may not have all features and functions described in this manual. This list represents our most popular options, additional option codes are available. Consult representative for more details.

Description of Unit

MegaTronXT controllers can control single or multiple recirculating water systems, including cooling tower and boiler applications, and may have various features depending on the model number.

Control Functions

Each of these control functions are based on an analog input from a probe and will include user settable relay control settings along with a High and Low Alarm setting and Limit Timer. Each control function will include a control relay output. When the reading reaches the Set Point, the control relay is activated until the reading changes by the Differential amount.

1. **System Conductivity** - The conductivity function of the controller is designed to monitor and control Total Dissolved Solids (TDS) in a recirculating system like a cooling tower or boiler in terms of electrical conductivity measured in MicroSiemens/cm. This control function is also referred to as Bleed.
2. **Make-up or Miscellaneous Conductivity** - This conductivity with the probe installed in the fresh make-up water line can be used to control the conductivity of the tower in terms of cycles of concentration by calculating the difference between the make-up water's conductivity and the system's conductivity. It can also be used to monitor another conductivity with no feed timers associated with it.
3. **pH** - The pH function monitors and controls pH on a scale of 0-14 pH units.
4. **ORP** - The ORP function monitors and controls ORP on a scale of +/- 1000 mV.

Chemical Feed Timers

Chemical feed timers are designed to automate the addition of various chemicals by activating a relay output. Multiple timers can be supplied depending upon the model number and each timer will include a relay output. All timers can be programmed to be one of the following types.

1. **Pulse Time** - Accepts pulses from a make-up water meter (supplied separately). It can accumulate 1-9999 gallons before activating the timer to run.
2. **Feed with Bleed** - Activates the relay output simultaneously with the bleed and limits the amount of time the relay output will be on during the bleed cycle.
3. **Feed after Bleed** - Activates the relay output based on a user defined percentage of time based on the bleed off, another timer or digital input. The relay is activated after a bleed cycle and runs for the set percentage of that bleed cycle.
4. **Recycle** - The relay is continuously repeating a defined OFF cycle time and a user defined ON cycle time.
5. **28 Day** - The timer is based on a 28 day cycle with four independent programmable feed cycles with prebleed and bleed lockout settings.

II. Intended Use



 The MegaTronXT is a microprocessor-based measuring and control instrument used to measure water quality parameters and other process variables in a wide range of water and wastewater treatment applications.

 Operating the instrument in any way other than as described in these instructions may compromise the safety and function of the measuring system and is therefore impermissible. Electrical connection work and maintenance work may only be carried out by qualified personnel. The manufacturer is not liable for damage caused by improper or non-designated use.

Mechanical Specifications

Electrical Input	100-230 VAC, 50/60 Hz, 2A rated	Relative Humidity	0 to 100%
Relay Outputs	Individually fused and 2.5 amps. Dry contact limited to 2.5 mA at 28 VDC.	Conductivity Control	µS/cm, mS/cm, PPM scales up to 50,000 depending on sensor selection
Display	6.875" Diagonal LCD Touch Screen	pH Control	0-14 with single or optional dual set point
Digital Inputs	Inputs have 10K Ω pullup to 3.3 VDC from open collector open drain output	ORP Control	+/- 1,000 mV, 2nd set point timer linked
Flow Totalizing Inputs	10K Ω pullup to 5 VDC max rate 2.5 KHz from open collector open drain output	Accuracy	+/- 1% of scale
mA Inputs	Optical isolation, 250 Ω / 5 VDC @ 20 mA. Loop voltage to not exceed 30 VDC.	Selectable Feed Timers	Water meter pulse, Percent, Post, Limit, Recycle, and 28 day with reminder 1 for loss flow.
mA Outputs	Non-isolated. 12 VDC max load = 400 Ω. Isolated ext 24 VDC max load = 800 Ω.	mA Input Control	Customizable to desired range and scale
Approvals	CE, UL61010-1& CSA C22.2 No. 61010-1-12 3rd edition + A1:2022 (R2022)	mA Output	Proportional with second input conditioning
Enclosure	NEMA 4X style polycarbonate	Tower probes supplied in 3/4" quick release PVC tees. pH and ORP probe bodies are CPVC.	
Ambient Temp	0° to 125°F (-17° to 52°C)	TE-4A	150 psi (10.3 bar), 140°F (60°C) max
Shipping Weight	Approximately 10 lbs. (4.536 kg)	TPE-21	100 psi (6.8 bar), 140°F (60°C) max
Dimensions	11" (27.94cm) W x 11.75" (29.84 cm) H	TOE-21	100 psi (6.8 bar), 140°F (60°C) max
		FS-OC (flow switch)	140 psi (9.6 bar), 140°F (60°C) max
		AL-4ASS	100 psi (6.8 bar), 212°F (100°C) max
		BE-32C	250 psi @ 400°F, SS/PEEK with 1" cross

Icon Definitions

Symbol	Publication	Description
	IEC 417, No. 5019	Protective Conductor Terminal
I	IEC 417, No. 5007	On (Supply)
O	IEC 417, No. 5008	Off (Supply)
	ISO 3864, No. B.3.6	Caution, risk of electric shock
	ISO 3864, No. B.3.1	Caution

III. Installation



A. Electrical Wiring Information

The controller has an internal regulated power supply that will operate in the range of approximately 100 to 230 VAC on the incoming wiring. Output relay(s) are protected with a replaceable fuse. Relay output voltage will equal the incoming line voltage.

Your controller will arrive from the factory prewired or ready for hardwiring. Depending on your configuration of controller options, you may be required to hardwire some or all of the input/output devices.

Note: When wiring the optional flow meter contactor input, the 4-20 mA outputs or a remote flow switch, it is advisable to use stranded, twisted, shielded pair wire between 22-26 AWG. Shield should be terminated at the controller at the most convenient shield terminal.

Prewired units are supplied with a 16 AWG cable with a 3-wire grounded USA 100 volt plug for incoming power and 18 AWG 3-wire grounded receptacle cords for all control relay outputs. Conduit units are supplied with liquid tights and adaptors for easy hard wiring to supplied connector.

 CAUTION 	
1.	There are live circuits inside the controller even when the power switch on the front panel is in the OFF position! The front panel must never be opened before power to the controller is REMOVED! If your controller is prewired, it is supplied with an 8 foot, 18 AWG power cord with USA style plug. A tool (#1 Phillips driver) is required to open the front panel.
2.	Low voltage signal wires (probes, flow switches, water meter, etc.) should never be run in conduit with high voltage (like 100VAC) wires.
3.	Never attempt to land connections to the controller without first disconnecting power from the outlet.
4.	Do not block access to disconnect power during mounting and installation.
5.	The electrical installation of the controller must be done by trained personnel only and conform to all applicable National, State and Local codes!
6.	Proper grounding of this product is required. The controller should be connected to its own isolated circuit breaker, and for the best results, the ground should be a true earth ground, not shared. Any attempt to bypass the grounding will compromise the safety of persons and property.
7.	Operating this product in a manner not specified by the manufacturer may impair the protection provided by the equipment.
8.	Only power device with cover installed. Never operate device with cover removed.

Additional Notes:

1. Liquid tight fittings and some labeled signal leads are provided for signal (low voltage) connections, such as water meter inputs.
2. Hall effect meters that require +12 VDC must use an external power supply (TFS-PWR).
3. Optional 4-20mA output is produced with 12 VDC on the loop. Do not connect output to devices that are trying to power the loop.

B.  Mounting Location Information

1. Select a mounting location that provides the operator easy access to the unit and a clear view of the controls through the cover of the controller. The location should be convenient to grounded electrical connections, the needed sample line plumbing and is on a stable vertical surface.
2. Do not block access to disconnect power during mounting and installation.
3. Avoid mounting in locations that expose the controller to direct sunlight, vapors, vibration, liquid spills or extreme temperatures; less than 0°F (-17.8°C) or greater than 120°F (50°C). EMI(electromagnetic interference) from radio transmissions and electric motors can also cause damage or interference and should be avoided.
4. Minimum screw / bolt size is #8 or larger.

Back Pane and System Card Connections

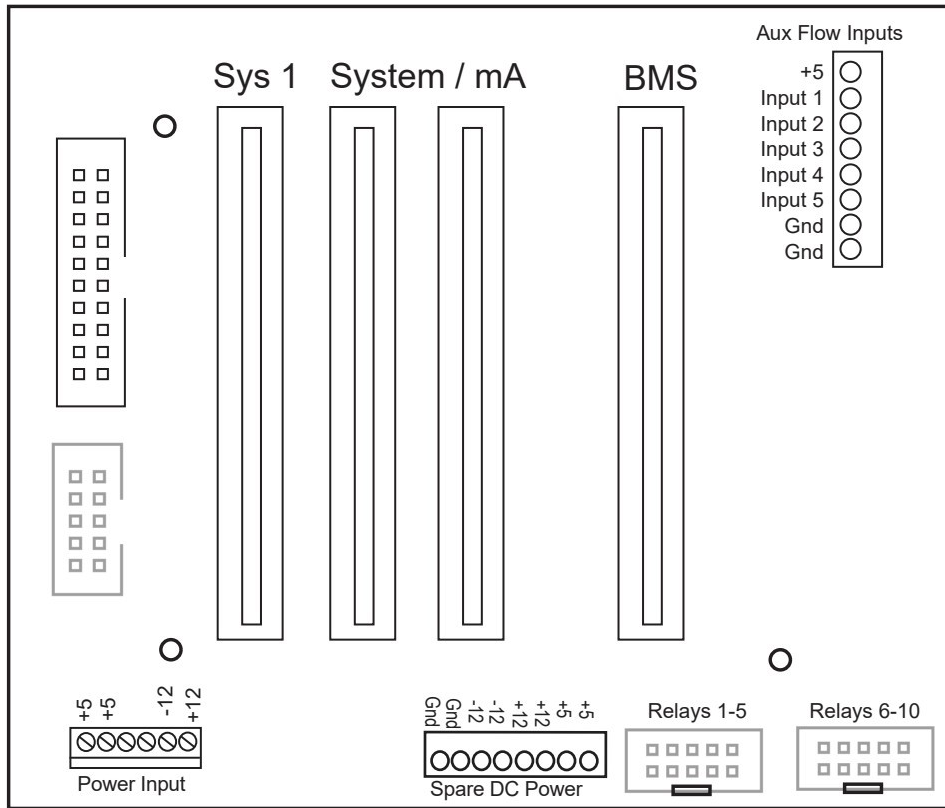

Option K7 Relay Card Wiring

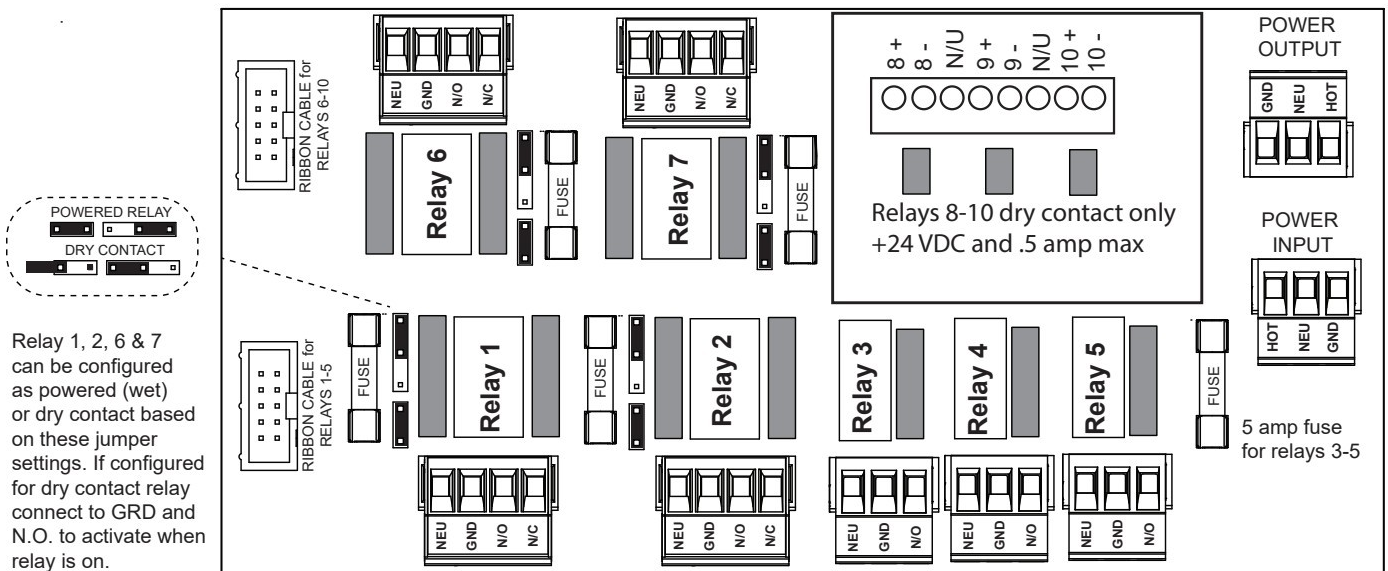

Relay 1, 2, 6 & 7 can be configured as powered (wet) or dry contact based on these jumper settings. If configured for dry contact relay connect to GRD and N.O. to activate when relay is on.

Wiring Diagrams

Standard 5 Relay Card Wiring

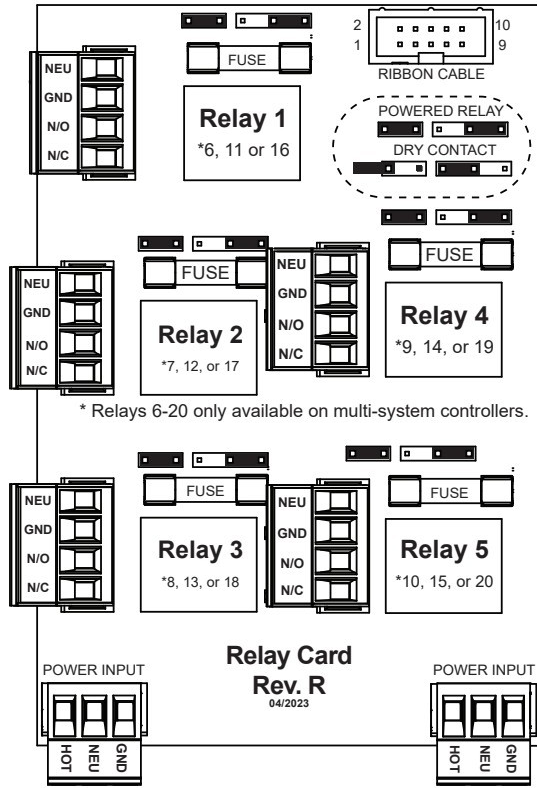

System Card Wiring

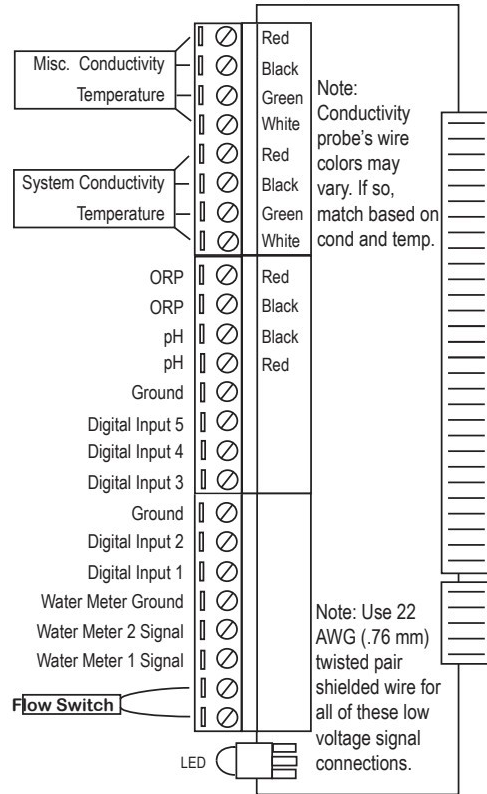

RTD Boiler System Card Wiring

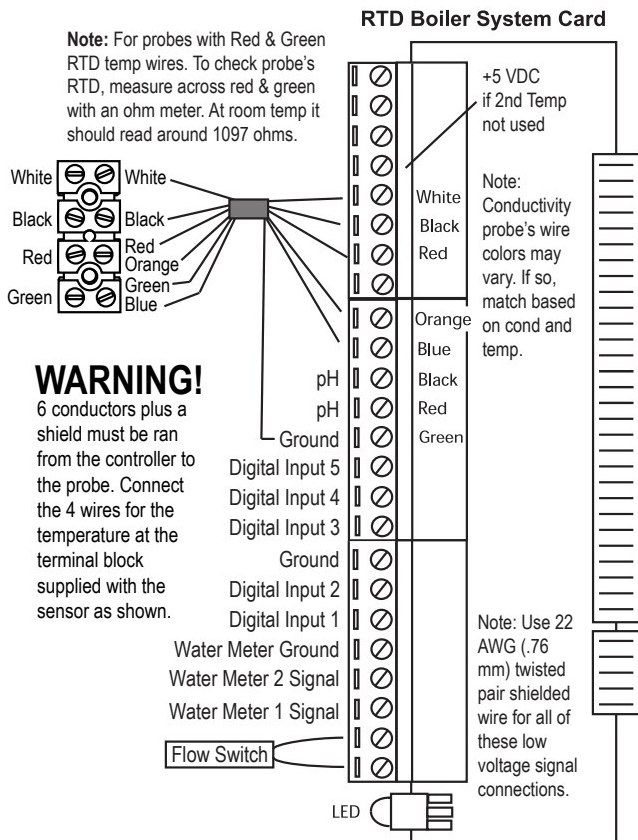

Option C8 Wiring

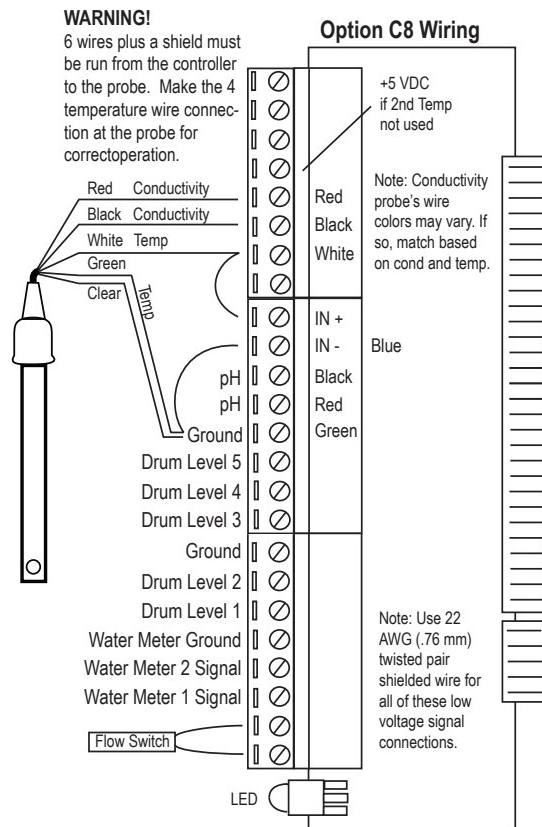

4-20mA Output Card Wiring

A. Isolated Configuration

For isolated 4-20mA outputs an external power source for the loop must be supplied. JP4 and JP5 on the board must be jumpered for isolated, with an external power source supplied to the external VDC input. The external power source must not exceed 24 volts DC.

B. Non-isolated Configuration

For non-isolated 4-20mA outputs the controller will supply the power for the loop. JP4 and JP5 must be jumpered for non-isolated, and no connections are made to the external VDC points.

NOTE: The power for the mA output loop is always provided by the controller with either isolated or non-isolated configuration.

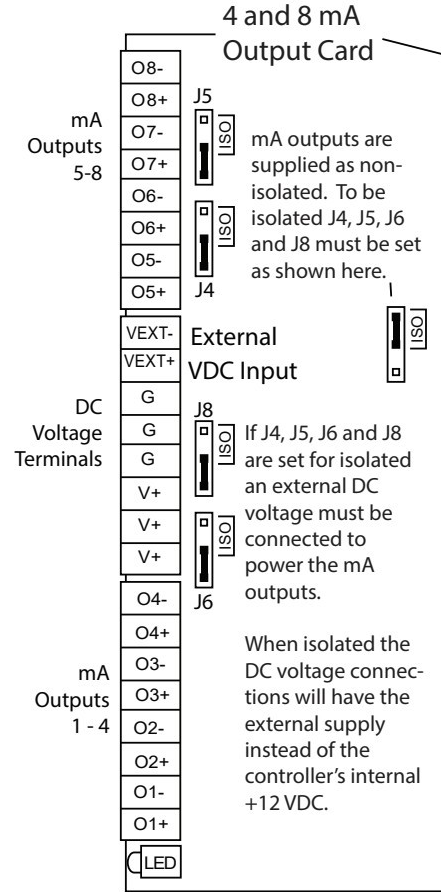

4-20mA Input Card Wiring

The 4-20mA input card requires that the external device sending the 4-20mA input signal(s) supply the power for the loop. The external power source must not exceed 24 volts DC.

NOTE: Older green versions of the 4 input cards supply +12 VDC and ground on the voltage terminals, and newer blue versions supply +12 and -12 VDC instead of ground on the "G" positions, if not configured for isolated voltage.

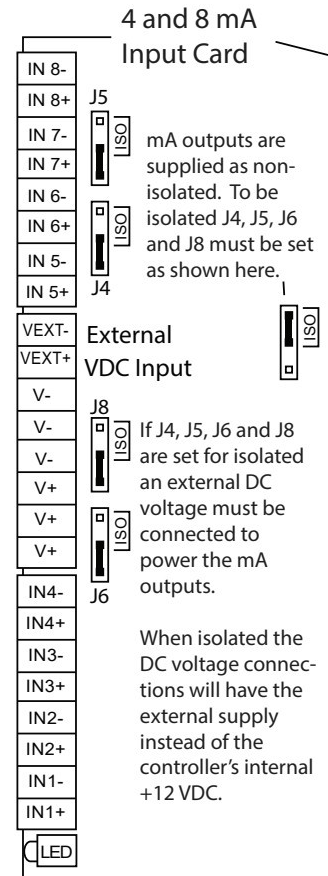

Electrode Installation

MegaTronXT controllers may come configured for various circulating water systems. Listed below are instructions for typical cooling tower and boiler installations. Your specific installation requirements may differ, but should conform to these instructions as much as possible for proper operation.

A. Cooling Tower

The standard probe(s) and/or flow assembly for cooling tower installations is constructed of schedule 80 PVC and supplied with ¾" slip fittings for installing into a sample line. To ensure proper operation the sample line must have a flow rate of 3-10 gpm. Inlet pressure must be higher than outlet pressure in order for water to flow past the electrode(s) to achieve the required rate. The probes are temperature compensated for increased accuracy.

NOTES:

1. **Install an isolation valve on either side of the flow assembly so electrodes can be easily isolated for removal and cleaning.**
2. **A line strainer is recommended upstream from the probes to protect against fouling and damage.**
3. **Mount pH or ORP electrodes vertically.**
4. **Green solution reference wire must be connected to either pH or ORP sensor. If both pH & ORP are present on the system card, only one solution reference connection is needed.**
5. **Systems with a flow switch require 2-3 gpm flow rate to operate outputs.**

WARNINGS:

1. **Electrodes are O-ring sealed, which, if damaged, will cause a leak.**
2. **Do not allow pH sensor tips to dry out, damage will occur.**
3. **Do not exceed a water temperature range of 32°F (0°C) to 140°F (60°C).**
4. **Do not exceed a maximum pressure of 125 psi (8.618 bar)**

Typical Cooling Tower Installation Diagram

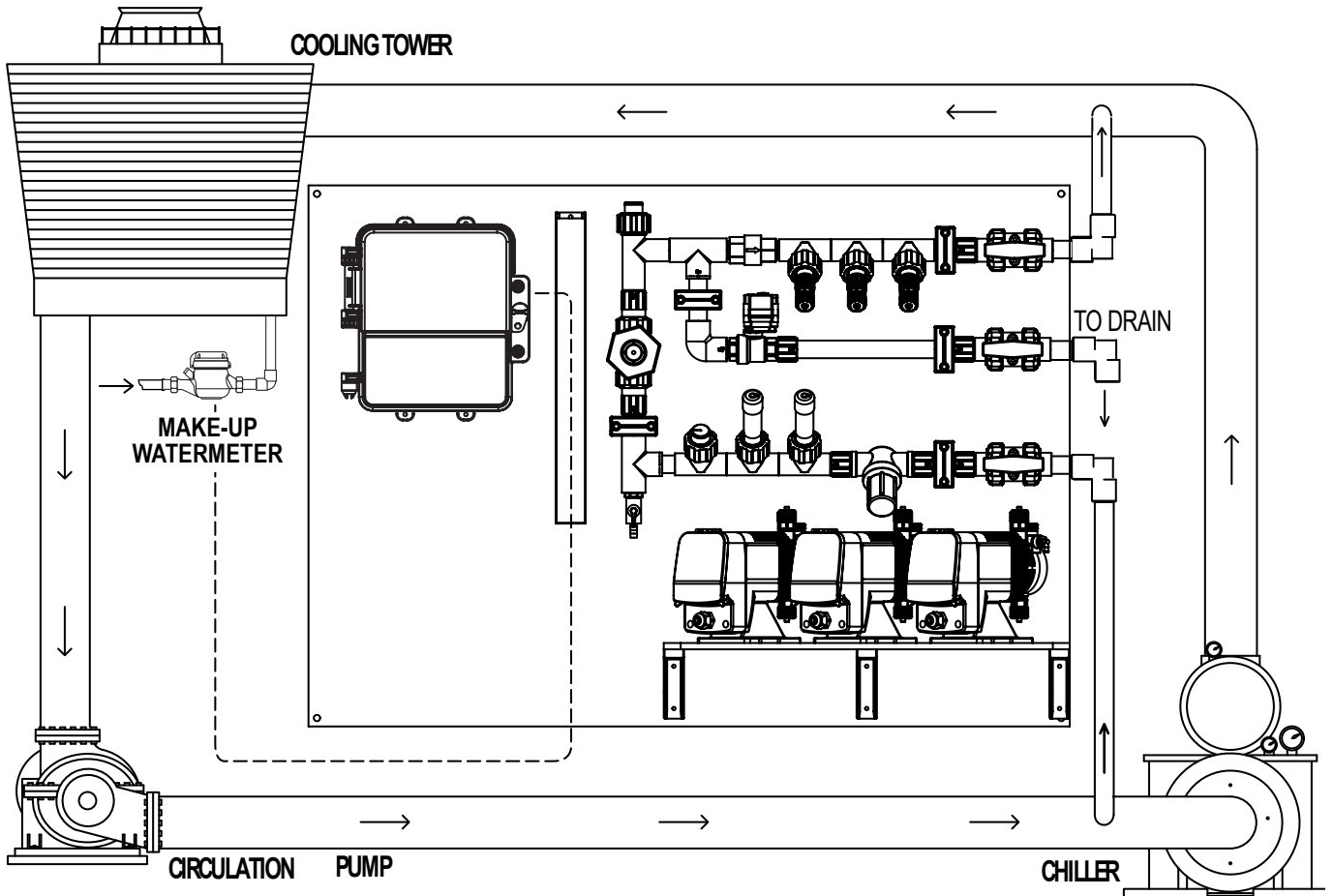

Cooling Tower Probe Assembly

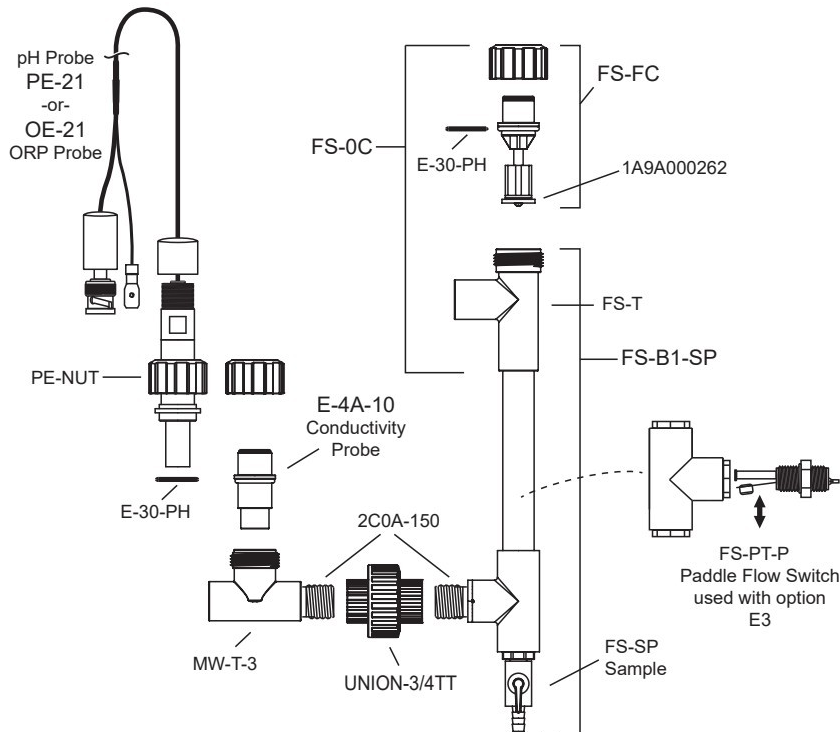

Standard Tower Probes

Conductivity	E-4A
pH	PE-2
ORP	OE-2

B. Boiler

Standard boiler electrodes have a MNPT stainless steel bushing and are supplied with a FNPT cross designed for mounting in the skimmer (surface) blowdown line. Sampling of the boiler's water can be achieved using one of two typical plumbing configurations (continuous sampling or timed and/or sample & hold). For a successful installation, it is critical to observe the recommended distances and pipe sizes provided in the installation drawings.

For best results, the electrode cross should be mounted in a 1" skimmer blowdown line within 4' of the boiler. Smaller line sizes and greater distances may affect the response time and accuracy of the electrode. A flow-throttling device downstream from the probe (within 24 inches) is required to ensure that the electrode is exposed to water and not steam. Properly installed and adjusted, this device will prevent flashing in the electrode chamber.

NOTES:

1. Install a fully-ported type of valve between the electrode and the boiler. This allows the electrode to be isolated for removal and cleaning.
2. A flushing line and ¼ turn type ball valve should be installed in the bottom of the cross to periodically "flush" sediment from the electrode chamber.
3. Make sure the alignment arrows on the probe end up parallel to the flow for best performance.

WARNINGS:

1. The probe must be fully immersed in the system water to read correctly. Steam flashing will result in incorrect readings.
2. Do not exceed a maximum water temperature of 436°F (224°C)
3. Do not exceed a maximum pressure of 350 psi (24.1 bar)
4. A throttling device must be installed downstream from the electrode.

Boiler Conductivity Electrodes

BE-4RTD and BE-32

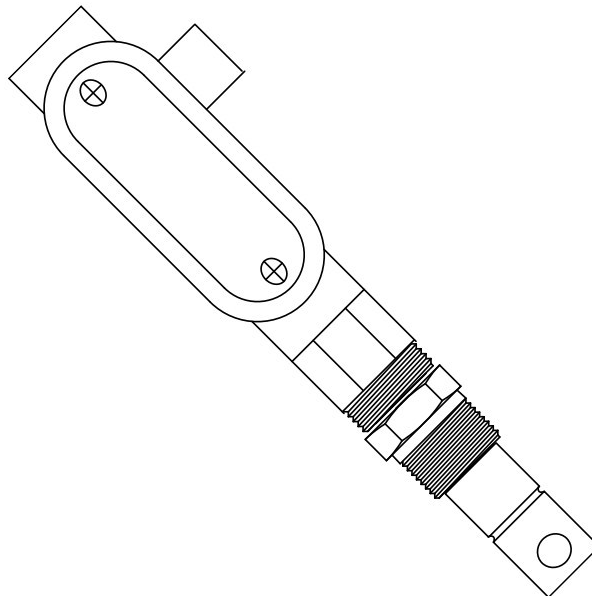

Wiring Note: BE-4RTD probes require a 6-conductor cable from controller to probe; BE-32 probes only require a 2 conductor cable.

Typical Continuous Sampling Installation

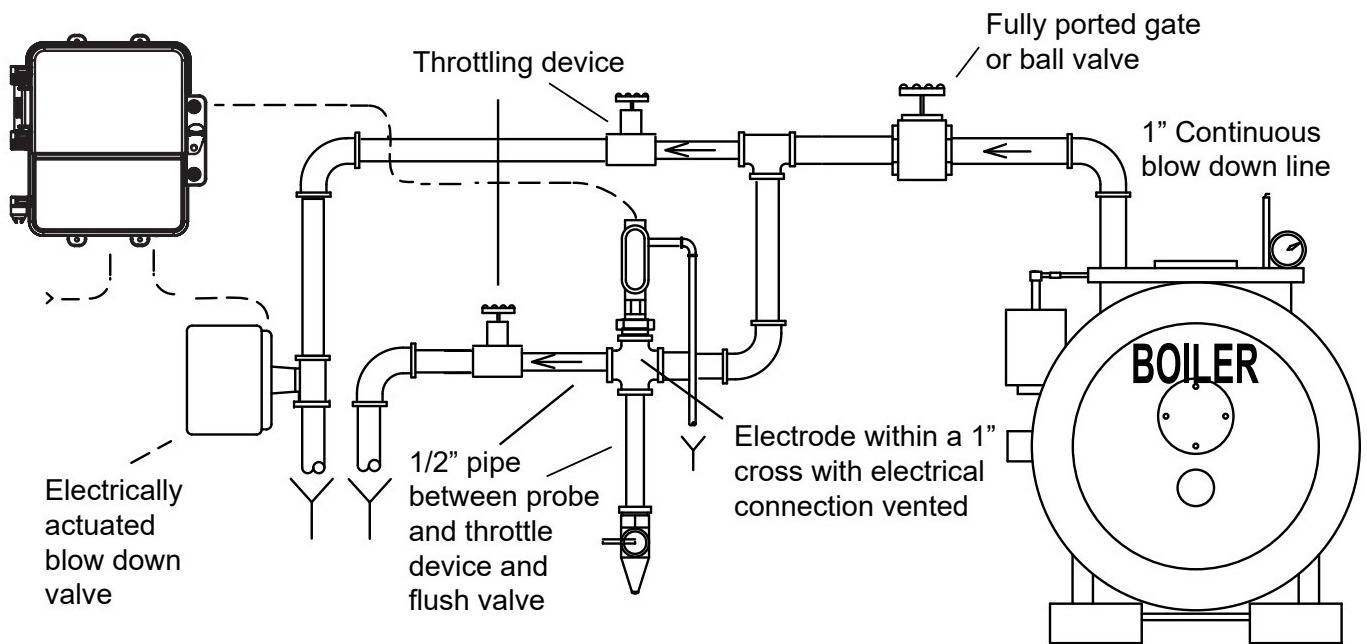

Warning - Do not use on bottom blowdown lines, only continuous or surface blowdown lines.

Typical Timed Sampling and Sample and Hold Boiler Installation

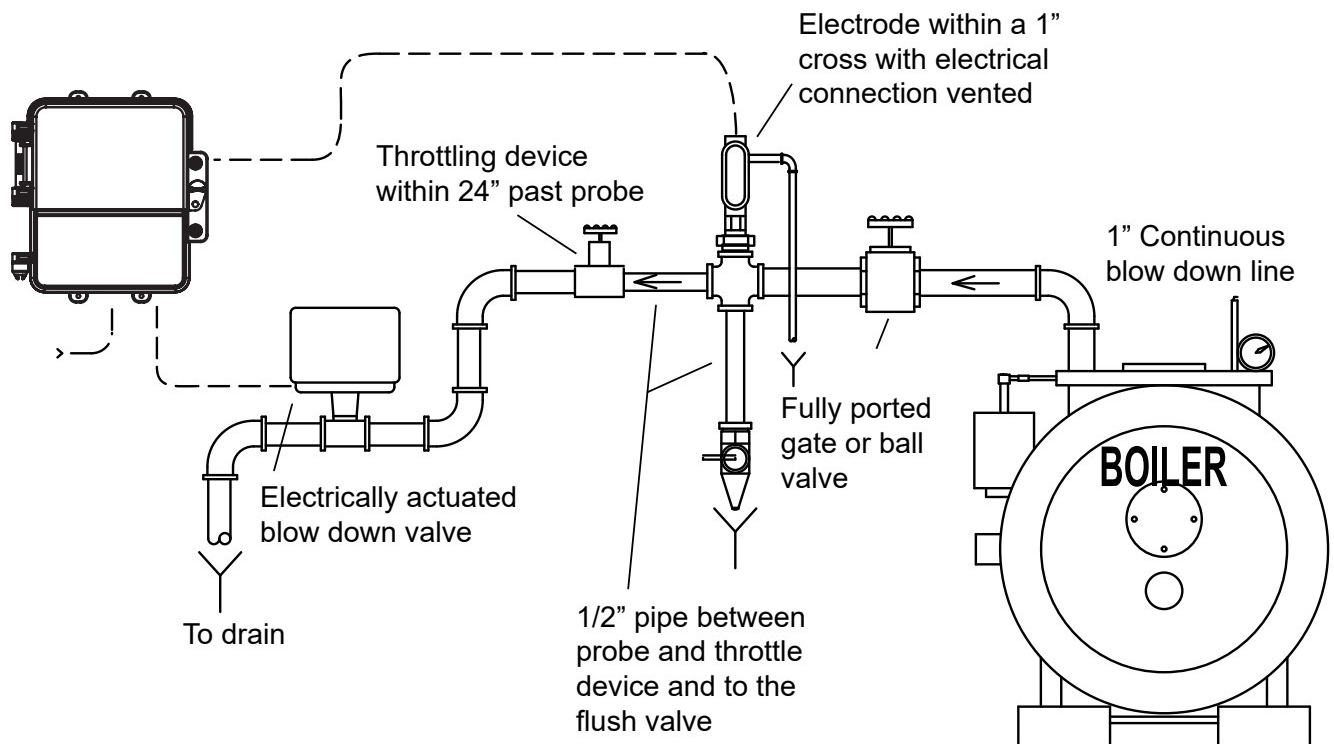

Warning - Do not use on bottom blowdown lines, only continuous or surface blowdown lines.

IV. Front Panel Description

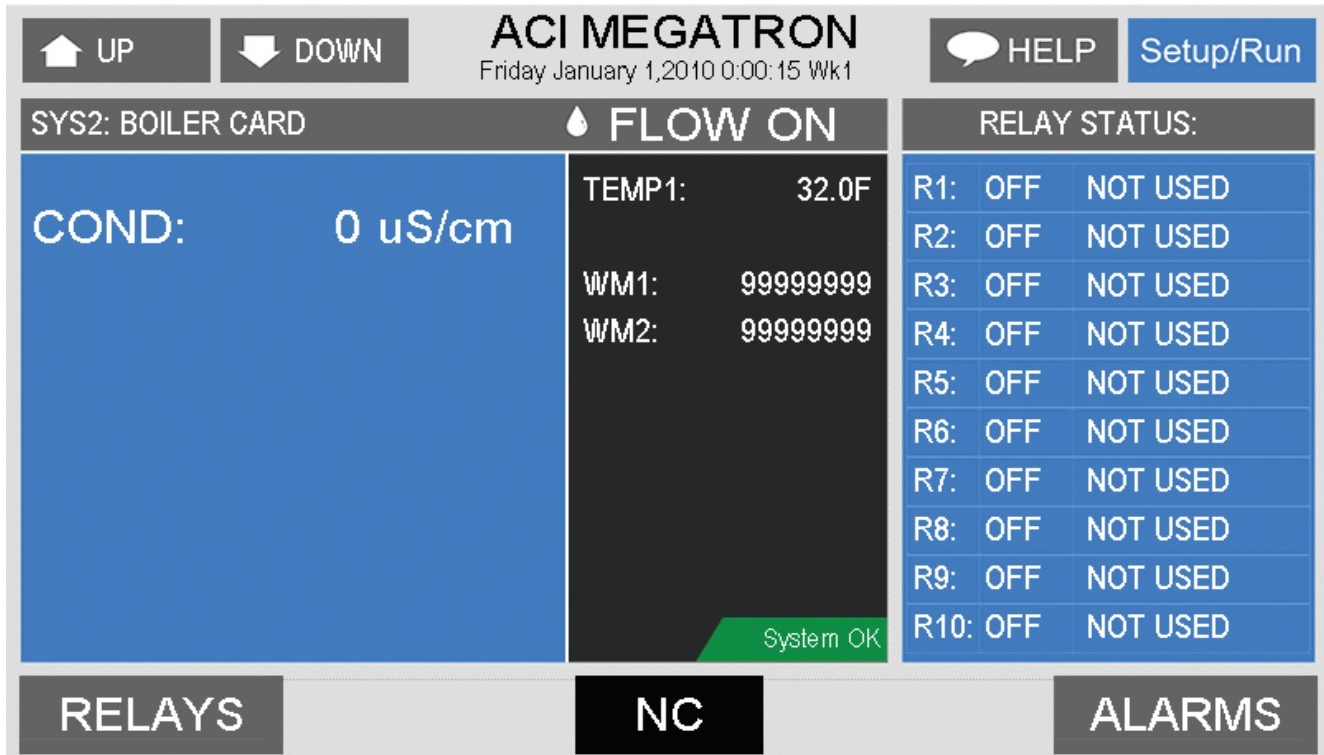

- SET UP/RUN - System initializes into RUN mode. Press this key to put the controller in SET UP Mode and see HOME menu page.
- HOME - Used to go back to the HOME menu page.
- HELP - Used to access help screens.
- BACK - Used to go back to last menu screen viewed or clear values keyed in that are not wanted.

The default is the RELAY status menu, but this can be changed by navigating to the desired screen and pressing the HELP button. Follow the on-screen instructions to set the new hot key location.

V. System Operation Overview

Operation

MegaTronXT controllers have two modes of operation, RUN and SET-UP.

RUN - This mode is for normal operation. In the RUN mode the display will show each system's parameters. If an alarm is present, the ALARM box will flash how many alarms are activated. No settings may be entered or changed in the RUN mode. Readings are updated every 6 seconds on the screen while in the RUN mode.

SET-UP - This mode is used to make adjustments to settings and readings on the controller. To access the SET UP mode from the RUN screen, press the SETUP/RUN key.

Typical Start Up Instruction

Complete all installation steps before beginning this procedure. Ensure that all controlled devices (pumps, solenoid valves, etc.) are operational and connected to the controller. Open the isolation valves to allow water to pass through the sample stream assembly. Before beginning the startup procedure, familiarize yourself with the programming and operation of the system by reviewing the menus available. Use the keys of the controller to skim through all your options.

A. Calibration

All MegaTronXT controllers are factory calibrated for temperature, conductivity, pH, and ORP. All units are shipped with the date preset, and the clock set to your current time. These readings and settings should be verified for accuracy, and adjusted as per the instructions listed below.

1. **Conductivity** - To calibrate the conductivity reading, remove the electrode from the line and wipe the flat surface with a clean cloth. Re-install the electrode and open the isolation valves to allow a sample across the probe. Be sure to allow the reading to stabilize for one minute. Select "SYSTEM COND" from the "CALIBRATION" menu. Then key in the corrected conductivity value. Press ENTER to log in that reading.

Note: Boiler probes must have a fresh hot sample. See page 16 for more details.

2. **pH** - Under normal operating conditions, pH calibration is achieved using the following steps. From the "CALIBRATION" menu, select "SYSTEM PH." Enter the correct pH value. Press ENTER to log in the new reading.

3. **ORP** - To calibrate ORP, from the CALIBRATION menu, select "SYSTEM ORP". Compare the displayed reading to the actual system ORP. If these readings do not match, key in the correct ORP value, and push ENTER.

There are limits to how much the calibration can be adjusted. The instrument will only accept new conductivity values which are from 1/3 to 8x the present reading. Any entry outside this range will cause a default to the original reading. If this happens, call 1-918-686-6211 for technical assistance.

VI. Menu Navigation

To access the menus, press the Set Up / Run key on the front panel. This takes you to the Home menu. MegaTronXT controller's menus are easily navigated by pressing the associated number key next to a menu box on the screen. Once you have stepped through the sub menus to reach a point at which a value or selection is made, a Pop-up window will appear prompting you to enter a desired value or selection.

NOTE: When entering new numeric values, enter all available digits (characters).

1. Home Menu

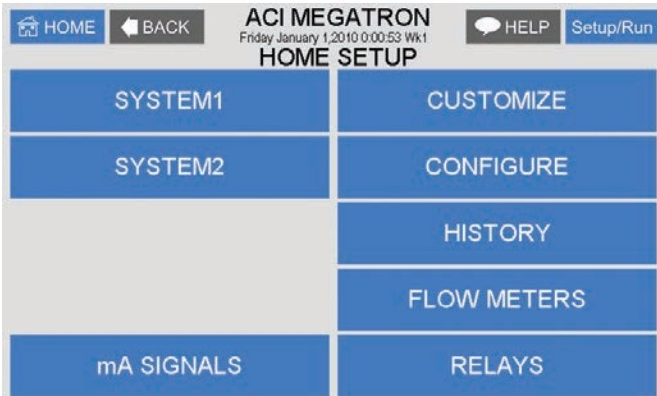

From the **HOME** menu select the desired menu. The menu name explains what parameters can be programmed in the menu.

- SYSTEM1 -** Setting control set points for conductivity, temperature, pH, and ORP for System 1.
- SYSTEM2 -** Setting control set points for conductivity, temperature, pH, and ORP for System 2.
- CUSTOMIZE -** Giving the controller, each system, mA input, and all relays a user-defined name.
- mA SIGNALS -** Menus for setting mA inputs and outputs calibration and control settings.
- CONFIGURE -** Menus for configuring passwords, relay activations, setting history interval, flow switch, contrast, temperature scale.
- HISTORY -** Allows for view history on board in a graph form.
- FLOW METERS -** Menu for configuring flow meter totalizing.
- RELAYS -** Menu for resetting accumulated "ON" times and manual relay activation.

2. Set Points

The same basic format is used for defining each available analog probe input's control parameters. Boiler conductivity systems will also have an additional menu step for programming the sampling method desired from continuous, timed or sample and hold.

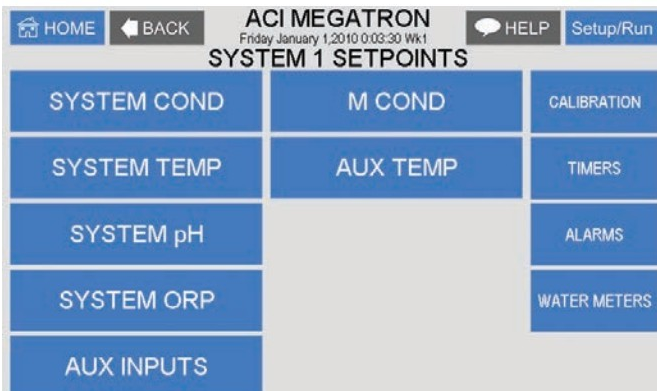

SET POINTS - For setting the relay set points for the available analog probe readings such as conductivity, pH, ORP, or temperature.

NOTE: In the Setpoint pop-up screen the direction (Rising or Falling) of the setpoint can also be set. Rising setpoints will activate the control relay when the particular probe reading rises above the setpoint and will stay activated until the reading comes down by the amount of the differential. If set for Falling the relay is activated when the probe reading falls below the setpoint and stays on until the probe reading comes back up by the amount of the differential.

2.1 Set Point Options

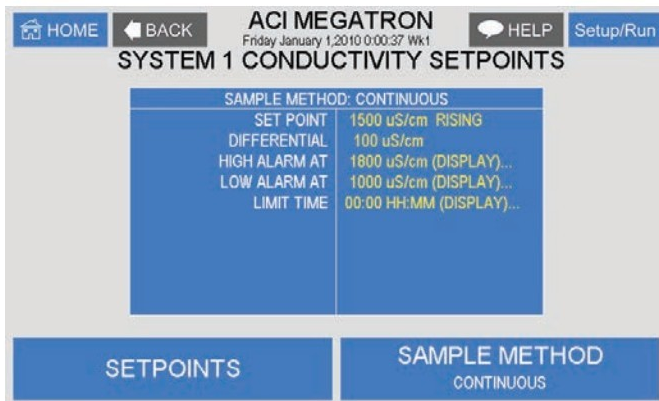

SET POINT - What reading turns the relay on.

DIFFERENTIAL - Amount reading changes by before the relay is turned off

HIGH ALARM - What reading generates a High alarm.

LOW ALARM - What reading generates a Low alarm.

LIMIT TIME - What amount of continuous bleeding will generate a time alarm notice. The bleed is not locked-out by this alarm.

Note: Each alarm value can also be set up to be displayed or not on the front screen, as well as remotely notified or not, if connected to the WebAdvantage server.

2.2. Make-up or Miscellaneous Conductivity

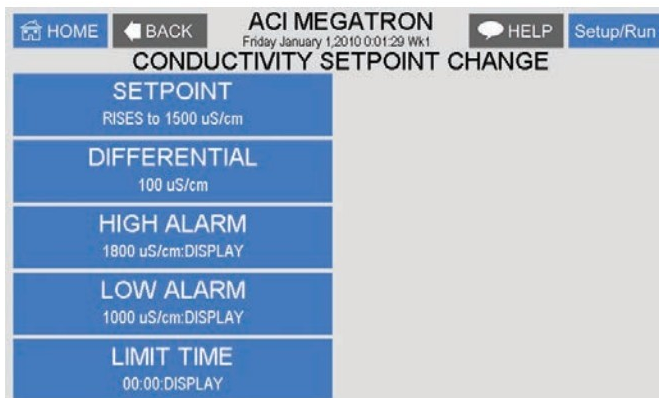

Tower systems with this option have an additional menu on the review page labeled SAMPLE METHOD. The sample method pop-up screen allows the user to select continuous or cycles control. With cycles selected under Settings, a best and worst cycles value is attached to a best and worst make-up conductivity value. The controller will control the cycles proportionally between the two cycles values as the make-up conductivity changes between the two identified values.

Note: If continuous is selected, the standard settings are used for system conductivity and the miscellaneous conductivity (labeled M COND) is the set points menus.

2.3. Boiler Conductivity

Conductivity on boiler systems can be configured for Timed Sampling, Sample and Hold, or Continuous, for the conductivity sampling method.

Timed sampling incorporates a sample timer which allows the boiler to be sampled at periodic intervals. Sample intervals are adjustable from 1 minute to 99 hours, 59 min. Sample duration (on-time) is adjustable from 1 second to 99 minutes, 59 seconds.

Sample and hold uses a sample timer for periodic sampling intervals. The unit will sample for its duration and then hold the blowdown valve closed for a settable period (hold time). The conductivity is checked at the end of the hold period, if additional blowdown is required the blowdown valve is held open for a preset amount of time (blowdown time). Then sample cycle is repeated.

Pulse Sample allows the use of a defined “pulse” type feed timer to initiate a sample based on make-up water instead of the sample interval timer.

Continuous sample has a sample of boiler or condensate water go past the probe continuously. If the reading is above the set point, blowdown will continue until the set point has been satisfied.

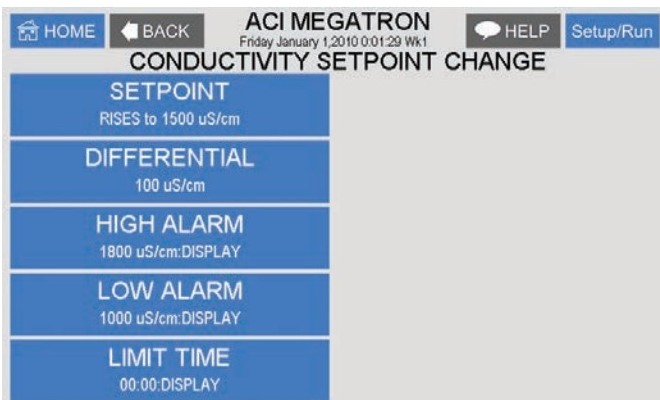

SET POINT - What reading turns the relay on
DIFFERENTIAL - Amount reading changes by before the relay is turned off
HIGH ALARM - What reading generates a High alarm notification.
LOW ALARM - What reading generates a Low alarm notification.

2.4. pH and ORP

The pH and ORP set point settings follow the same format as shown above in section 2.1.

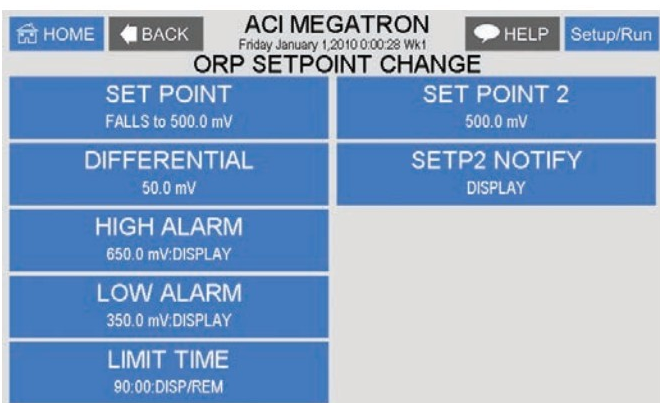

INTERRUPT - Only applies to pH settings and allows the Interruption of pH control during bleed, other chemical feed, or both.
ORP SET POINT 2 - If a 28-day timer is interlocked to ORP, the ORP control will go off of SET POINT 2 during the 28-day timer's run time.

Note: When the Limit Time value is met it will force off the control relay being driven by pH or ORP. To reset the limit timer and get the control relay active again, enter a new Limit Timer value.

2.5. Aux Inputs

Auxiliary inputs are the digital inputs for optional Flow Switch and other digital inputs, such as low drum level alarms. From these menus, alarms, notification, action, and latching settings can be made.

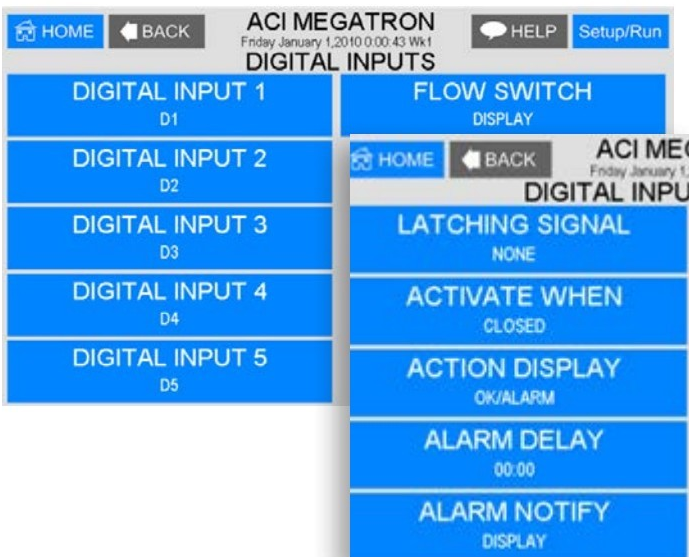

LATCHING SIGNAL - Allows a digital input to stay Active until a second latched input becomes active.
ACTIVE WHEN - Set if input is active seeing closed or open.
ACTION DISPLAY - Set if the input is being set as alarm or just On/Off.
ALARM DELAY - How long input must be in open/closed before registering.
ALARM NOTIFY - Set the alarm notification.

2.6. Calibration

Calibration is for adjusting the displayed value of a probes reading to match your tester or known solution. Pick the system or mA input first. From a particular system, pick the probe to calibrate.

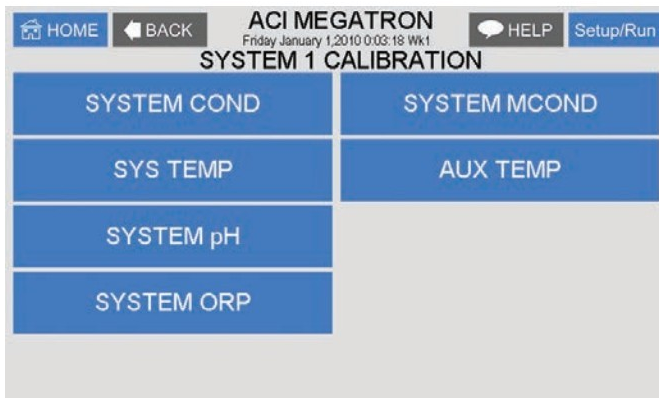

CALIBRATION - For adjusting the actual reading values of the available analog probe inputs, such as conductivity, pH, ORP or temperature.

2.6.a. Conductivity Calibration

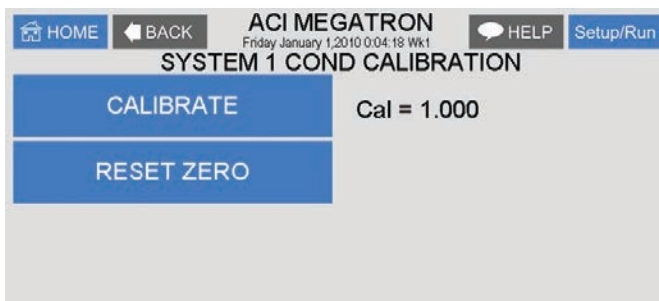

CALIBRATE - With a clean probe on-line seeing the system's water enter the known (tested from a calibrated handheld tester) value.

RESET ZERO - With the probe out of solution and dry, enter a new zero point. **Note:** Probe must be dry!

NOTE: In the calibration pop-up window, the raw analog-to-digital (A/D) value will be displayed. A new calibration value should only be entered when the probe is sensing a stable A/D value. If the system is a boiler the associated relay can be forced on in the pop-up to allow for a fresh hot sample. Boiler probes should have fresh hot water blown past them for a minimum of 2 minutes before calibrating. **The A/D reading has a range of 0 to 32,767. If it is at one end of the range or the other when trying to calibrate, something is wrong with the probe or wire run.**

2.6.b. pH and ORP Calibration

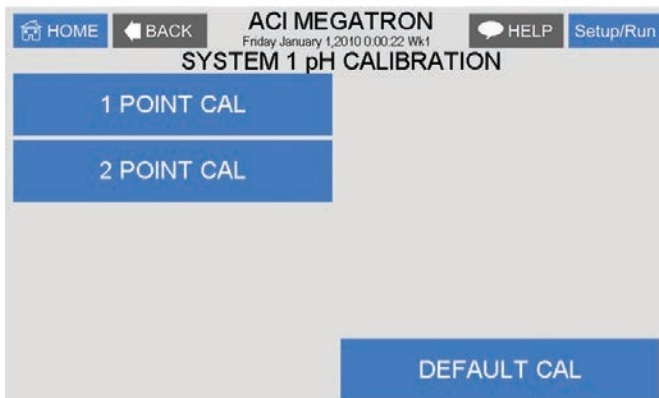

1 POINT - With a clean probe on-line seeing the system's water enter the known (tested from a calibrated handheld tester) value.

2 POINT - Enter a known Low value with a clean probe in a buffer solution. Then enter a known High value with the clean probe in a buffer.

Notes:

1. Probes must be rinsed between buffers when doing a 2 Point calibration and given at least 30 seconds in solution to adjust to the buffer.
2. There must be at least 2 full pH points between buffer solutions. Using a buffer of 4 and 10 is the best procedure. ORP buffers should be at least 200 points apart.

2.7. Timers

A unit may have up to 5 selectable timers for each system on a controller. All timers are associated with their system, so for a % of post bleed timer looks at the bleed of that system.

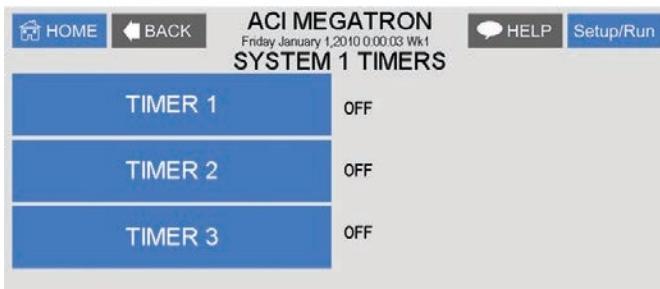

TIMERS - Select the type (28-Day, pulse, limit, percent, recycle, percent of post bleed, or other event), as well as the run times of each timer available per system.

2.7.a. Timer Type Selection

A pop-up screen lets you scroll through the various timer types available.

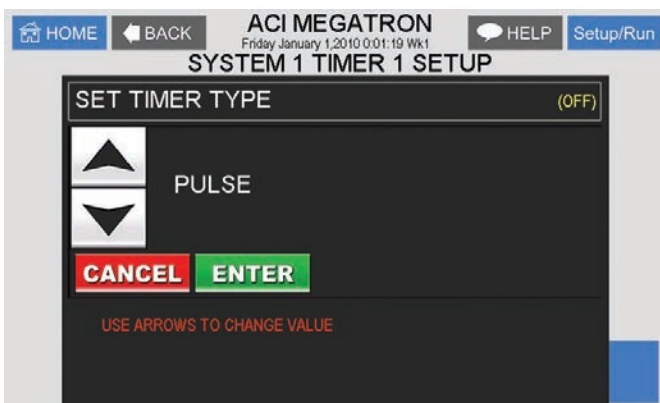

Pulse - A water meter activated timer.

Limit - Feed with bleed with a maximum run time or limit for one bleed cycle.

Recycle - A continuous recycle timer with ON and OFF settings.

Percent Post Bleed - For feed after bleed for a settable percentage of the bleed time with a maximum run time.

28-Day - A biocide or event timer.

2.7.b. Timer Set Up



Each timer type selected will have its own unique Set Up submenu with additional selections specific to the type of timer selected. The page displayed before entering the Set Up menu of a timer provides an overall review of the timers current settings.

27.c. Pulse Timer

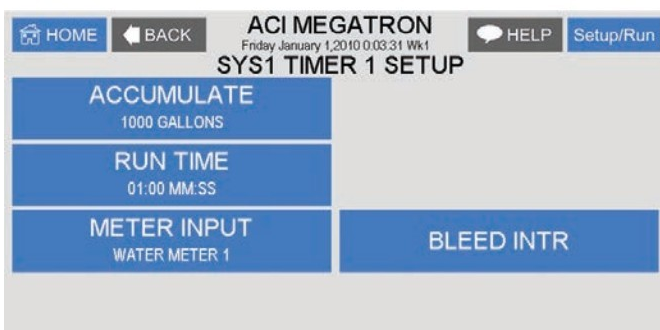

ACCUMULATE - The number of gallons or liters from water meter to count before activating timer.

RUN TIME - The amount of time for the timer to run

METER INPUT - Select water meter 1 or 2 for the timer's activation. Water meter 1 + 2 can be selected only if the meters have the same contact value.

BLEED INTR - Allows the pulse timer to be interrupted during conductivity bleed. While interrupted, you can also define the maximum number of timer run-cycles (1-9) to store for playback.

2.7.d. Recycle Timer

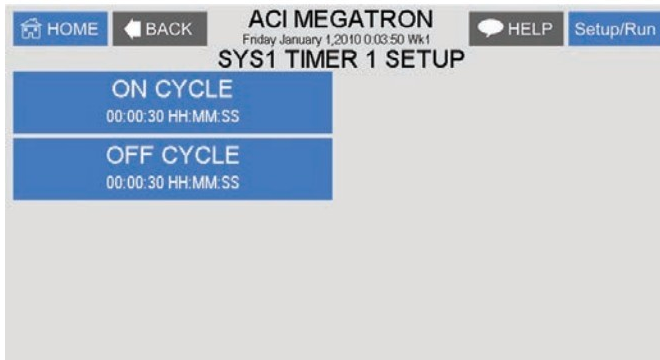

ON CYCLE - The amount of the defined time that the timer is to be on.

OFF CYCLE - The amount of time that the cycle will be off.

ON/OFF TIMER - This is the displayed countdown of time for the cycle the timer is in.

2.7.e. Post Bleed Timer

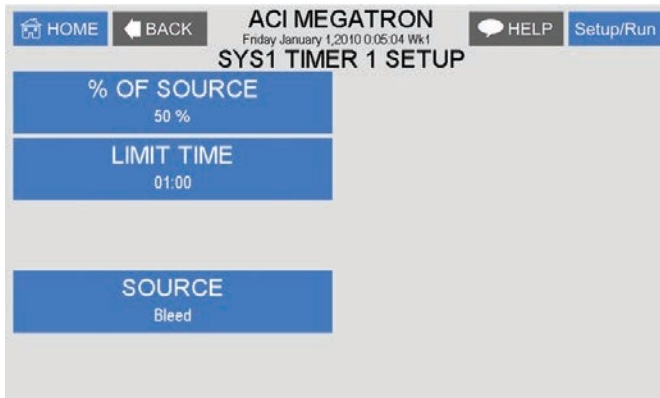

% of SOURCE - The % of the post bleed time or other source time that you want the timer to run.

LIMIT TIMER - The limit timer is a safety feature that limits a single feed cycle to the amount of time set, regardless of the calculated post feed %.

SOURCE - Select between cond. bleed, another timer or digital input as the time source.

2.7.f. With Bleed Timer



LIMIT TIMER - This timer starts when the conductivity bleed starts and turns off when the bleed stops or until the limit time has been reached. The time can be set in MM:SS.

2.7.g. 28-Day Timer

Each 28-Day timer has Program 1-4 for programming the various feed times. While the programming steps for four programs are the same, each can have its own independent settings.

ACI MEGATRON Friday January 1, 2010 0:09:33 Wk1	
SYS 1 TIMER 1 PGM 1 CHANGE	
WEEKS NO WEEKS	MIN COND 1 uS/cm
DAYS SUNDAY	FEED LOCK NONE
START TIME 00:01	BLEED LOCK 00:00
RUN TIME 01:00	FLOW LOCK W/ OR W/O FLOW
PREBLEED 00:01	ORP LOCK NOT INTERLOCKED

WEEKS - The week(s) that the timer is to feed.

DAYS - The day(s) that the timer is to feed.

START - The time of day for the timer to start.

RUN - How long the timer is to run.

PREBLEED - How long the controller is to bleed down before feeding in chemical. **Note:** The prebleed starts at the START time programmed above.

MIN COND - The minimum conductivity that the unit will prebleed down to.

FEED LOCK - Which other system timer to lockout during this timer's run time.

BLEED LOCK - How long to lock out the bleed function after the timer's run time starts.

FLOW LOCK - 3 selections if a system has a flow switch:

- Only With Flow - If there is no flow at the start time no feed occurs.
- With or Without Flow - Feed occurs regardless of flow condition.
- Flow Only/Store1 - If there is no flow at the start time, one run cycle will occur when flow does come on. Only one run will occur regardless of how many more than 1 are missed due to no flow.

NOTE: ORP lock is only for systems with the ORP function. If interlocked, the ORP setpoint will switch to the 2nd setpoint for control during the timer's programmed RUN time. The feed device must be connected to a relay activated by the ORP setpoint/control function.

2.8. Alarms

ACI MEGATRON Friday January 1, 2010 0:03:26 Wk1	
ALL ALARMS	
SYS1 DIGIN 1 D1	SYS2 DIGIN 2 D2
SYS1 DIGIN 2 D2	SYS2 DIGIN 3 D3
SYS1 DIGIN 3 D3	SYS2 DIGIN 4 D4
SYS1 DIGIN 4 D4	SYS2 DIGIN 5 D5
SYS1 DIGIN 5 D5	SYS2 LO COND
SYS1 LO COND	SYS2 LO TEMP 1
SYS1 LO pH	
SYS1 LO ORP	
SYS1 LO TEMP 1	
SYS1 LO TEMP 2	
SYS1 LO MAKEUP COND	
SYS2 DIGIN 1 D1	

ALL ALARMS

ALARMS - Shows any current alarms. Accessible from the Setup/Run screen.

2.9. Water Meters / Totalizers

Each system with a timer on it will have 2 water meter inputs. Each of these can have the incoming contact defined, allowing the controller to keep track of water usage. If desired, the controller can calculate evaporation loss by subtracting the difference between a system's two water meter inputs.

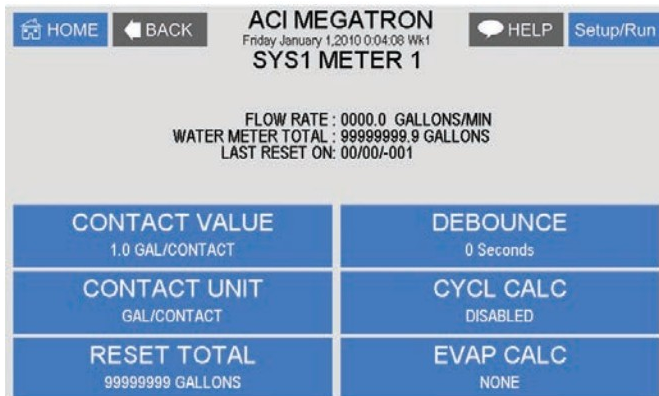

CONTACT VALUE - Defines the numerical value for a contact; i.e. 10.

CONTACT UNIT - Defines the units of measurement for a contact; i.e. Gallons / Contact. If there is a mA input set for a gpm or lpm reading, that mA input can be selected in the Contact Units as the source for the meter input to total flow rate.

RESET TOTAL - Resets the totalizer count.

EVAP CALC - Defines which way to subtract the two water meter inputs for an evaporation value.

DEBOUNCE - An additional amount of time the input will wait before accepting another water meter contact to reduce false contacts from a chattering read switch.

2.9.a. Option W Totalizers

MegaTronXT controllers with "W" option may have 1 to 4 auxiliary flowmeter inputs. These additional inputs are for tracking various flow meter devices (additional water meters or flowmeters in a metering pump's discharge tubing). They can also be linked to a system's water meter input for additional tracking and alarm capabilities, including bleed flow/no flow, exceeding too much flow in a 12- or 24-hour period. Units with Auxiliary Flow meter inputs have a Home menu selection for Totalizers. The Totalizer menu has selections for each of the System Water Meters, plus one named Aux Meters.

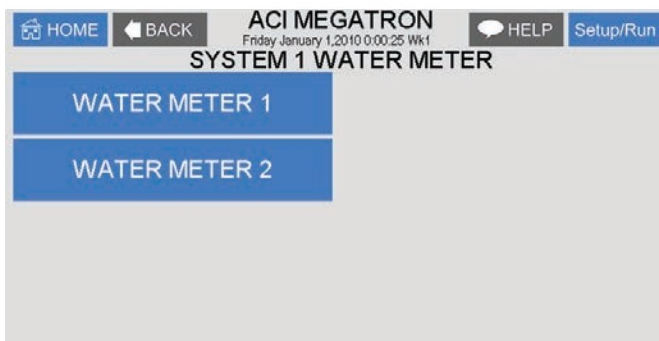

Select the system water meter to set up or go to Aux Meters to set-up the auxiliary flow meters.

3. mA Signals

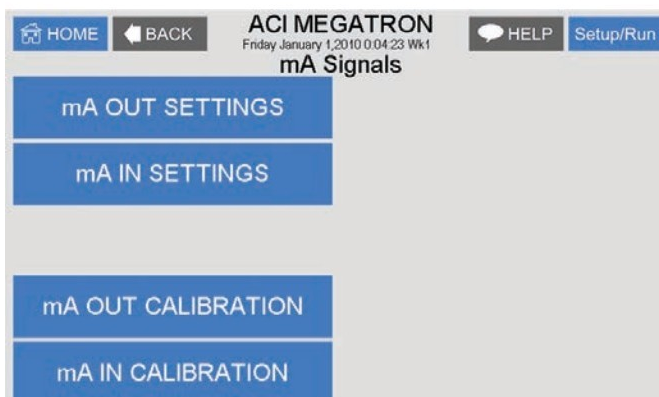

mA OUT SETTINGS - Selecting source and range of outputs.

mA IN SETTINGS - Setting control and alarms for inputs

mA OUT CALIBRATION - Calibrating outputs.

mA IN CALIBRATION - Calibrating inputs and displayed range.

3.1. 4-20mA Out Settings

Units with a 4-20mA output option will have a menu for setting up the 4-20mA output. The 4mA and 20mA values can be defined by giving the output proportioning capability. i.e. 4mA = a pH of 6.0 and 20mA = a pH of 8.0.

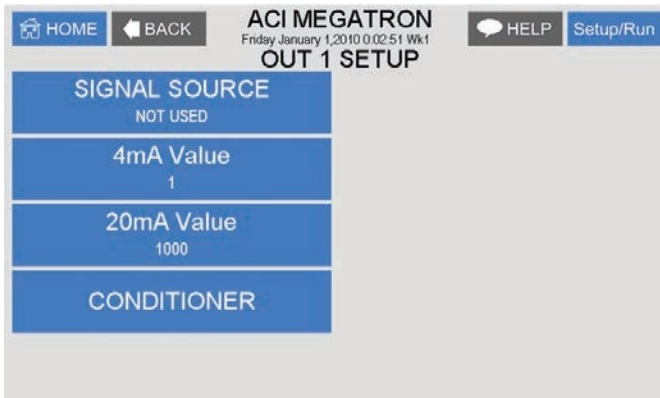

SIGNAL SOURCE - Select which probe reading the mA will use as its reading source.

4 mA VALUE - What the 4mA signal equals

20mA VALUE - What the 20mA signal equals on the assigned signal sources scale.

CONDITIONER - Select a second reading that can change or condition the original mA output.

3.2 4-20mA Input Settings

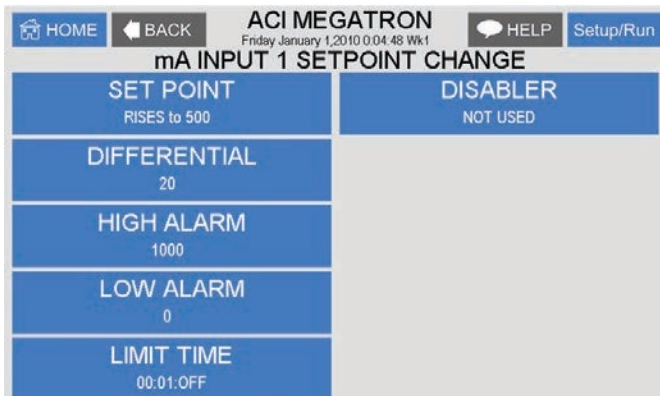

SET POINT - What reading turns the relay on

DIFFERENTIAL - Amount reading changes by before the relay is turned off.

HIGH ALARM - What reading generates a High alarm notification.

LOW ALARM - What reading generates a Low alarm notification.

DISABLER - Selected input will disable HIGH/LOW alarm notifications and a control relay being activated by the input's setpoint.

3.3 4-20mA Output Calibration

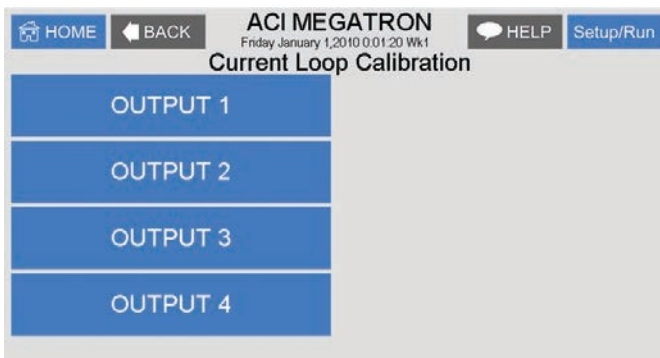

4-20mA outputs can be calibrated to ensure that the output generated by the controller and received by the external device match. With a voltmeter connected across the out and return wires (see page 7) of the 4-20mA output channel, to be calibrated, go into the output's Low or High calibration.

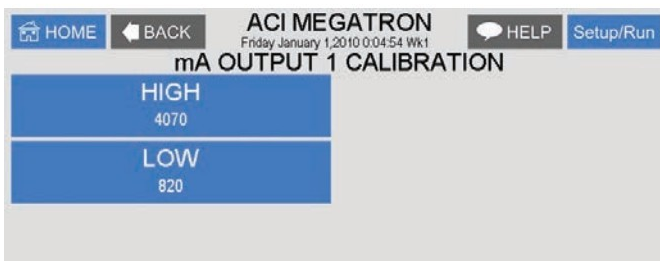

The number displayed in the Calibration dialog box can range from 0-4,095, with 800 equal to 0 mA output, and 4,030 equal to 20 mA. This number range of 0-4,095 is the raw digital-to-analog (D/A) values and is strictly used for reference. The D/A numbers that you get will vary based on your installation conditions.



While in the High or Low calibration pop-up screen use the up and down arrows to change the output value being read with the voltmeter. Adjust the High value for the 20-mA reading and the Low value for the 4-mA value.

3.4 4-20mA Input Calibration

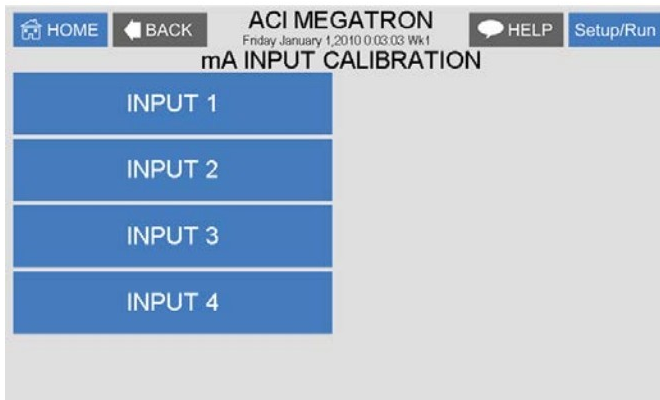

4-20mA inputs can be calibrated to ensure that the input seen by the controller from the external device match. It also allows for setting the 4-20mA input into a number range that relates to the value being read.

Select the Input to be calibrated.

Firmware version XT.16.03 and newer have logic that suspends any control logic if the mA received is 50% below the stored 4mA value. A # will be placed in the RUN screen for any mA value in this invalid state.

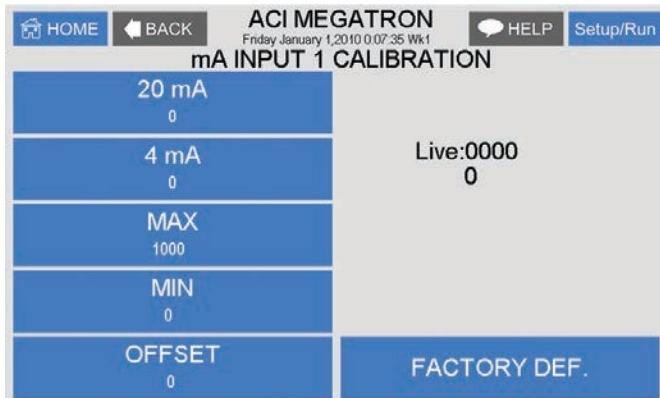

The **20mA** and **4mA** values are where the controller's raw analog to digital value is adjusted to match a 20mA (full scale) and 4mA (bottom of scale) signal from the external device inputting the 4-20mA input. The external device must be connected to the controller and showing either full or bottom of scale when calibrating each. The number shown along with either the 20mA or 4mA while calibrating is the raw A/D value, and is only a reference. A 20mA input should be around 5,500, and 4mA around 1,100. If the A/D numbers are not in this range, check the input device.

If a mA Input is receiving an A/D value 50% below the stored value for 4mA, the reading is viewed as invalid, and control logic is suspended. This is represented on the RUN screen with a #.

The **MAX** and **LOW** calibration inputs define what to display for a 20mA input and a 4mA input. For a drum level sensor on a 55-gallon drum, the value for **MAX** should be 55 and **MIN** should be 0. A number is automatically displayed between 55 and 0 based on the input value. The scale and units of measure (gallons for example) are set in the Customize menu from the Home page. If the decimal position is changed in Customize, all mA input settings and **MIN/MAX** will need to be reset.

OFFSET - Changes the current displayed value of the 4-20mA input reading to allow for a manual 1pt calibration of the displayed value.

FACTORY DEFAULT - If the 20mA or 4mA calibration has been incorrectly set (not at 4 or 20) this will reset the settings back to a factory value for 4 and 20.

4. Customize

This menu allows the user to define the on-screen name of the unit plus the name of each system and relay. The user can also set up the Notepad for each system and 4-20mA Input's name and unit of measurement.

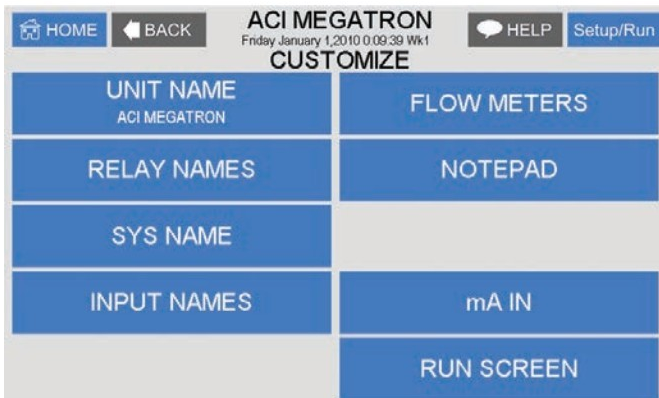

RUN SCREEN - Allows the user to select what will be shown on the screen while the controller is in the RUN mode, such as displaying temperature readings, water meter totals for a particular system, or the conductivity units of measure.

NOTE: When entering values for custom names use the numerical keys for numbers and the up / down arrows to scroll through all the characters of a keyboard. Press the right arrow to advance the cursor after setting a desired value. Press the Help button to place the last entered character into the new cursor space to speed up the process. The Help button will also jump advance through the characters.

4.1 Notepad

The Notepad function allows the user to set up and store manually entered data or perform simple calculations between two different sensor or notepad inputs. There are ten notepad fields per system card and each can be given a custom name, UOM and number range.

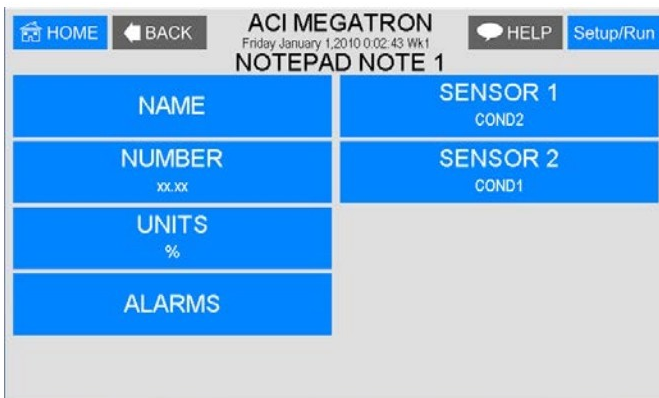

NAME - Pick from a list of defined names or customize your own or if you want the Notepad to be a Calculation.

NUMBER - Set the number range.

UNITS - Set the units of measurement.

ALARMS - Set Hi/Low alarm points and how frequently a new value is expected to be manually entered via the History menu.

If the Notepad is a calculation no time alarm is defined and the calculation results are stored in history at the time stamp interval.

CALCULATION - If a Notepad is to be a calculation select the type of calculation desired.

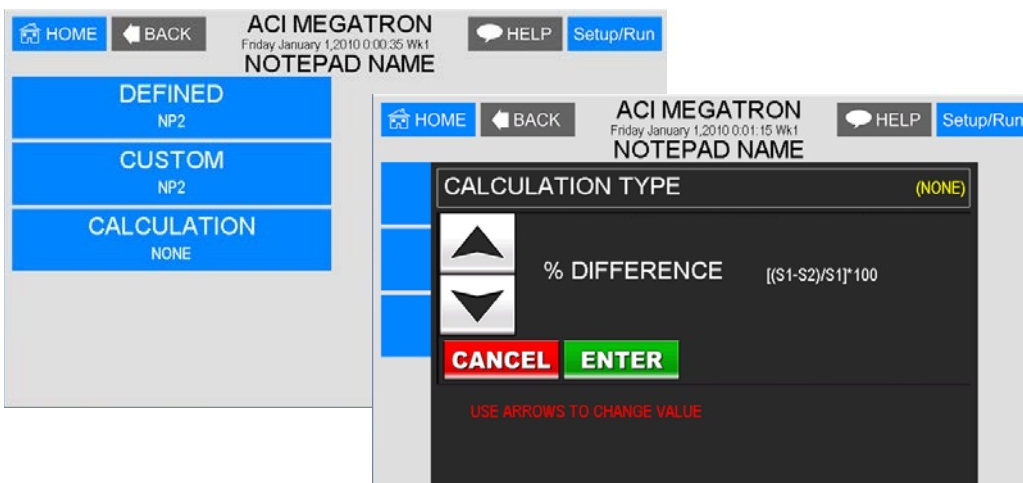

Calculation Types:

- None
- % Increase
- Product
- Total
- Ratio
- % Difference
- Difference

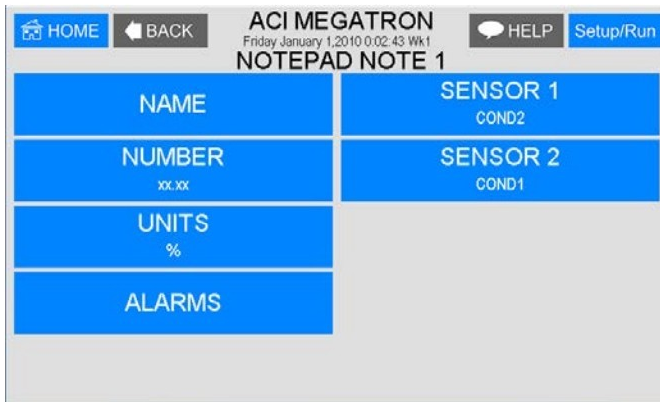

SENSOR 1 - The first sensor reading or Notepad value to be used in the calculation.

SENSOR 2 - The second sensor reading or Notepad value to be used in the calculation.

4.2 mA Inputs

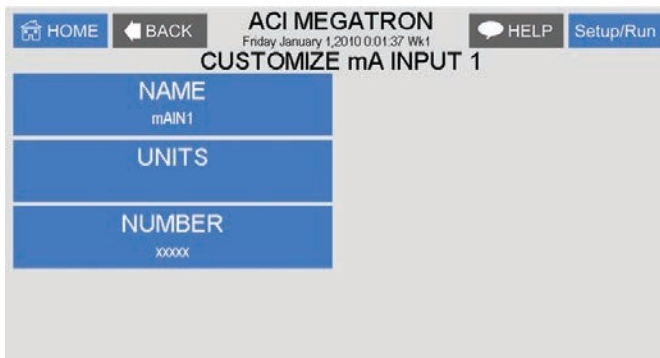

NAME - Name the input.

UNITS - Set the units of measurement.

NUMBER - Set the number range.

4.3 Run Screen

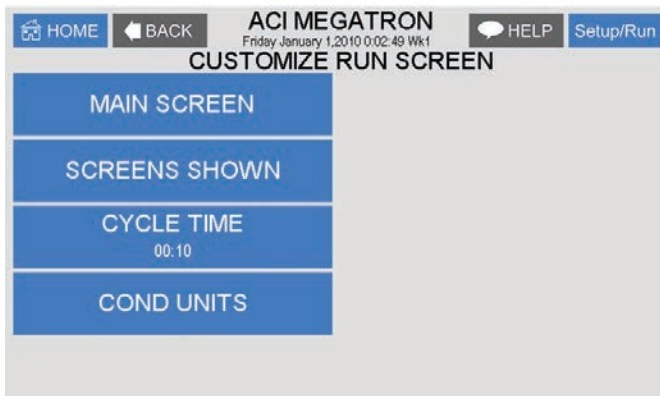

This lets you customize various aspects of the RUN screen.

MAIN SCREEN - Customize what is displayed on the RUN screen.

SCREENS SHOWN - Pick if the mA input & Aux Flow screens are scrolled.

CYCLE TIME - The amount of time between screen scrolls.

COND UNITS - Select the units of measure to be displayed with the conductivity reading.

5. Configure

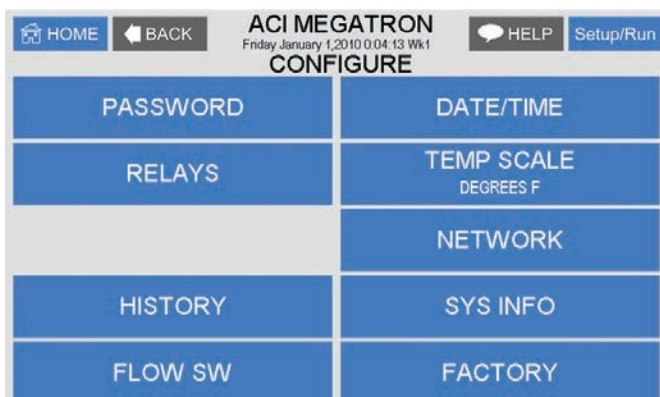

Provides access to menus to set-up passwords, relay activation, temp scale, display contrast, flow switch, inputs, history time stamps, factory set-up and system information.

FLOW SW - Defines a flow switch to be open or closed with flow.

FACTORY - A factory only menu

TEMP SCALE - Set Celsius or Fahrenheit

HISTORY - Sets the history time stamp interval.

SYS INFO - Tells unit software specifics.

5.1 Password

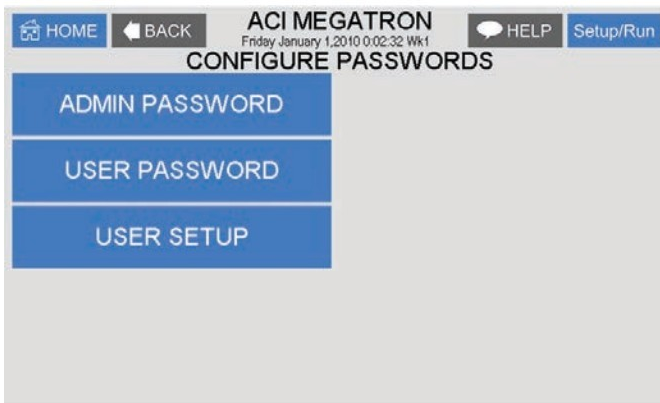

ADMIN PASSWORD - The administrator password gives access to all menus except factory set up.

USER PASSWORD - The user password allows the user to access HOME menus that are made available in USER SET UP.

5.2 Date and Time Set Up

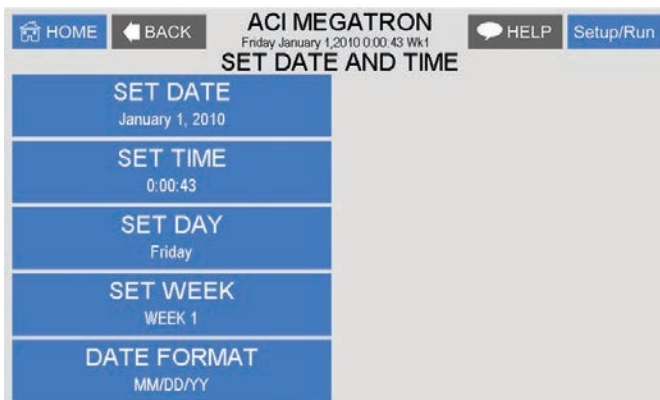

DATE AND TIME - For setting the date, time, day, and week on the controller.

5.3 Relays

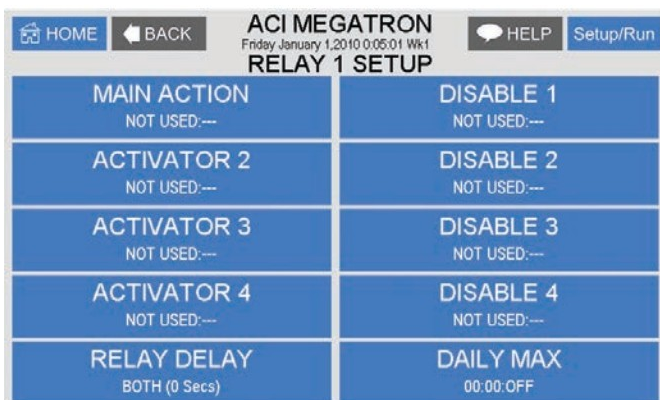

CONFIGURE RELAYS - This menu lets you choose a **Main Action** or function (timer 1, conductivity, alarms etc...) to activate a relay.

A pop-up screen appears with a list of all available activation functions to arrow through.

Additional relay logic is available with up to 3 additional **Activators** and up to 4 **Disablers** allowing multiple functions to activate the same relay and multiple functions to prevent the relay from coming on. There is also a Daily Max amount of time that a relay can be on. If a relay is on for the max amount, it does not let the relay come on anymore that day (a 24-hour clock is used for the day with midnight being the start of the day). The Delay setting is the amount of time a control function must come on before the relay will react and activate. This is to prevent a relay from chattering on/off if a reading is bouncing around the set point or alarm.

5.4 History

This menu is used to set the history “time stamp” interval, the water meter daily history starting hour, the alarm delay period and the USB history save format.

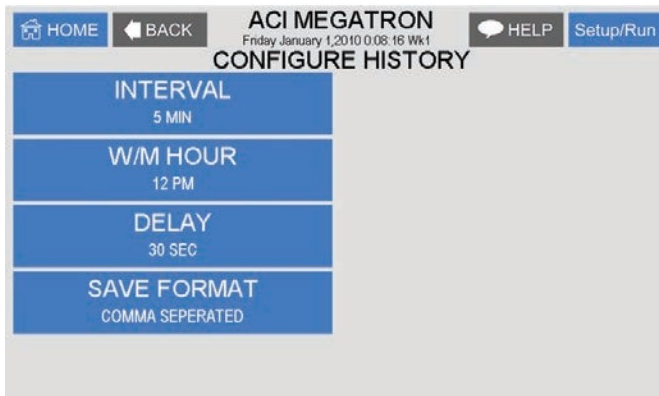

INTERVAL - The amount of time between each history time stamp for probe readings.

W/M HOUR - The time of day that the daily water meter history cycle is to start.

ALARM DELAY - The amount of time an alarm has to be on before it is recognized as an alarm.

SAVE FORMAT - The USB history save format.

5.5 Flow Switch

This menu allows the user to select if a flow switch signal will represent a flowing condition when a “closed” or “open” signal is seen for each systems flow switch input. Users can also select if timers can work always or only with flow.

5.6 Temperature Scale

This menu is used to select the type of temperature scale to display.

5.7 Network

The Network menu is used when a controller is being remotely communicated with either a local network connection or over the internet on the WebAdvantage server. IP Address, IP Mask, Gateway, and other information can be viewed from this menu.

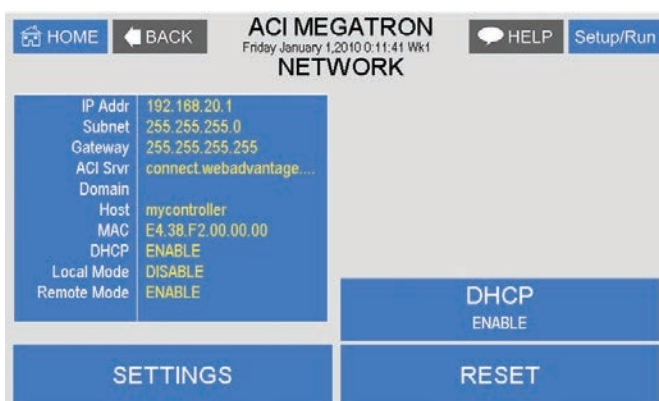

SETTINGS - This menu is used for setting up the remote WebAdvantage communications and is covered in a separate manual.

<http://www.advantagecontrols.com/downloads/pdf/M-WebAdvantage.pdf>

Note: The Network card must be RESET after making any changes to Network setting in order to save changes and reset communications.

5.8 System Information

System information will identify the version of firmware installed in the controller along with the controller’s serial number.

6. History

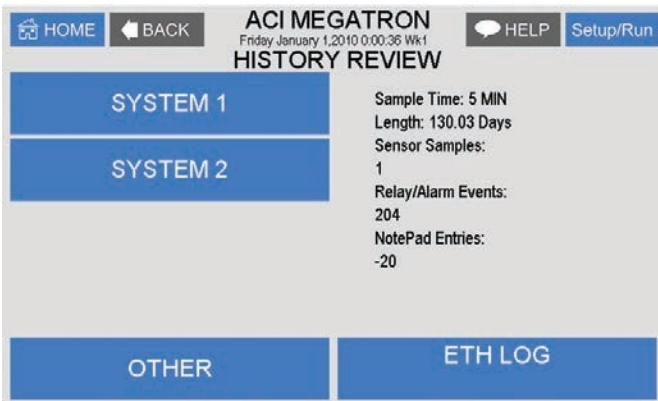

The onboard history allows for viewing the history of the probe readings, relay activations, key-pad activity, calibrations, water meter hourly and daily logs, and alarms for each system present. It is also where Notepad data is entered and reviewed. An initial overview page is displayed showing your current sample interval, the calculated number of days the unit can keep probe history for before losing the oldest. The number of sensor samples and relay/alarm events and Notepad entries currently stored is also displayed.

NOTE: The history can be reset by going to the configure menu and entering a different sample interval. After the new sample interval has been set, the onboard history is reset.

6.1 Viewing History

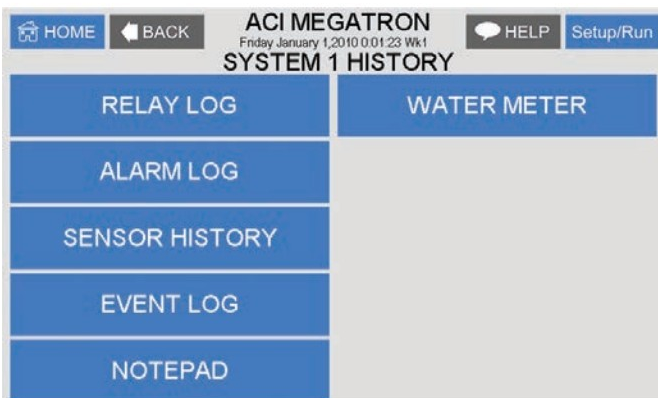

RELAY LOGS - Relay activations displayed in a log form. Arrow up to advance through the log.

ALARM LOG - Alarm activations in log form. **SENSOR HISTORY** - For selecting the parameters and viewing of a given probe reading's history in log or graph form.

EVENT LOG - Displays various activities.

6.2 Notepad Entries

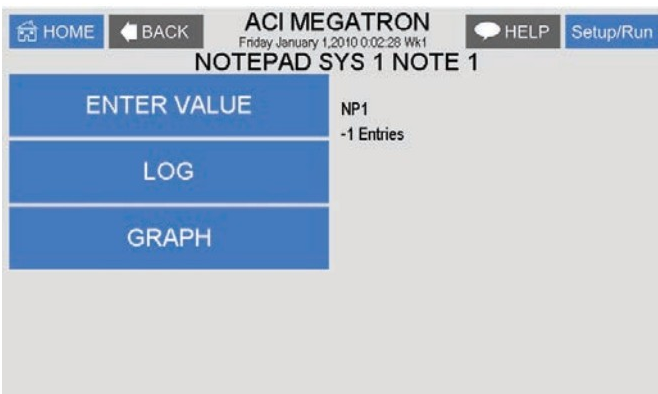

The Notepad section under History is where the user goes to enter new values for the customized notepad items. Each individual notepad item's manually entered entries are stored in the unit's history and can be reviewed in log or graph form after 4 or more values have been entered.

6.3 Water Meter History

The water meter history allows the user to review both water meter one and two of a particular system in both an hourly format (for the past 24 hours) or a daily format for the past 60 days. If an evaporation calculation is being kept, a daily history of this value is also available.

7. Flow Meters

ACI MEGATRON Friday January 1, 2010 0:02:27 Wk1	
HOME	BACK
FLOW METER	
FLOW METER 1	FLOW METER 6
FLOW METER 2	FLOW METER 7
FLOW METER 3	FLOW METER 8
FLOW METER 4	FLOW METER 9
FLOW METER 5	FLOW METER 10

A unit may have up to 10 option auxiliary flow meter inputs. These additional inputs are for tracking various flow meter devices like Advantage Controls' FloTracker in a metering pump's discharge tubing. They can also be linked to a system's water meter input for additional tracking and alarm capabilities.

Select the Aux Flow Meter to set-up or review.

7.1 Flow Meter Setup

The Flow Meter setup gives the user access to the various settings for the flow meter along with a review of the current settings.

ACI MEGATRON Friday January 1, 2010 0:02:48 Wk1	
HOME	BACK
AUX FLOWMETER 1 SETUP	
PULSE VALUE 1.0 GAL/CONTACT	VOLUME ALARM
UNITS GAL/CONTACT	RESET VOLUME
RESET TOTAL 99999999 GALLONS	METER LINK NONE
VERIFY ALARM 10 Secs	LAST RESET ON : 00/00/001 FLOW RATE : 0000.0 GALLONS/MIN FLOW METER TOTAL : 99999999.9 GALLONS
RELAY LINK NO RELAY	TRACKING RATE & VOLUME

PULSE VALUE - Defines the numerical value for a contact, i.e. 225.

UNITS - Defines the units of measure for a contact, i.e. Pulses / Ounce.

RESET TOTAL - Resets the totalized count of the meter.

VERIFY ALARM - If a flow meter is linked to a control relay, the controller will give an alarm if it does not receive a contact or pulse from the aux meter within the amount of time defined, or if it gets a contact when the relay is not on.

RELAY LINK - The relay link informs the Aux meter input is relevant to the control function that the selected relay is being driven by. For example, if the Aux flow meter is a metering pump's FloTracker then it should be linked to the relay that is driven by the feed timer that pump will be controlled by. If the Aux meter is going to be linked to a water meter in a bleed-off line then it should be linked to the relay that is controlling the bleed off valve.

VOLUME ALARM - If FloTracker has been selected as the Tracking method, an alarm will occur when the defined VOLUME USED has passed through the flow device.

Note: If Rate and Volume tracking has been selected an alarm will occur if the defined MAX VOLUME amount is measured within the defined TIME CYCLE which can be a 12- or 24-hour period.

RESET VOLUME - Resets the Volume Alarm totalizer.

METER LINK – This selection only shows if the tracking method is Rate and Volume and tells the auxiliary flowmeter input to get its signals from one of the system water meters already wired to the controller's water meter inputs. If this is selected, no wiring to the auxiliary input is required and the PULSE VALUE and UNITS settings are auto populated from the water meter's settings.

TRACKING - Provides a pop-up screen to select either FloTracker or Rate and Volume tracking.

8. Relays

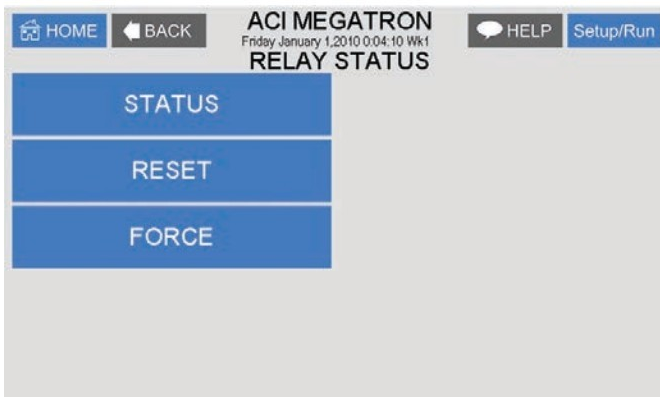

STATUS - Allows for viewing accumulated relay ON times, temporary forcing relays ON or OFF or seeing which relay is on.

RESET - Allows the accumulated run time of a particular relay to be reset to zero.

FORCE - Allows a relay to be manually forced ON or OFF for a single event from 0-999 minutes. When the event is over the relay goes back to its normal automatic control.

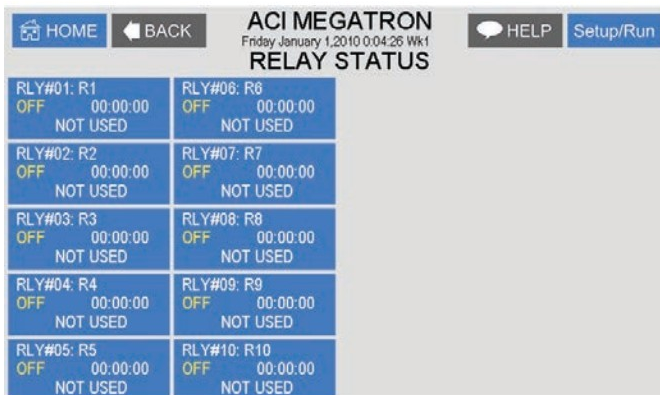

In the STATUS view the accumulated ON time is shown along with the main activator, custom name and current status:

ON = Relay on by relay activators

OFF = Relay off by normal logic

OFF-T = Relay off for daily max

OFF-D = Relay off for relay disabler

ON-A = Relay activated by activator other than main action

H-ON = Relay manually forced on

H-OFF = Relay manually forced off

VII. Maintenance

The only required maintenance for normal uninterrupted operation of your MegaTronXT controller is cleaning of the electrode(s). After initial startup, it is a good idea to clean the electrode frequently until a schedule based on need has been developed. Since each application is unique, it is difficult to estimate the required frequency of cleaning. The first cleaning should take place after about one week of the system being online.

To determine the required cleaning frequency, record the reading on the controller before the electrode is removed for cleaning. After cleaning, record the new reading. If a change is observed in the two readings, the electrode was dirty. The more significant the change, the dirtier the electrode. If no change occurs, cleaning needs to be done less often.

Conductivity Electrode Cleaning Procedure

1. Record the current conductivity reading.
2. Turn off water flow through the electrode loop, bleed pressure from the line and remove electrode.
3. Use a clean cloth and a mild cleaning solution to remove loose dirt etc., from the flat surface of the electrode.
4. If the electrode has deposits such as scale attached to the electrode surface, a more aggressive cleaning approach will be needed. There are several ways to do this, the preferred method being the one that is easiest for the user.
 - a. Use a mild acid solution to dissolve deposits.
 - b. Lay a piece of sandpaper (200 grit or finer) on a flat surface such as a bench top. "Sand" electrode to remove stubborn deposits. Do not wipe the surface with your finger. Oil from your skin will foul carbon tips.
5. Reinstall the electrode in the system. After the reading stabilizes, calibrate the unit to a reliable test reading.

Many times, an electrode can appear to be clean, but the unit still cannot be calibrated. If this is the case, use one of the more aggressive electrode cleaning procedures listed in step 4 above. Recheck the calibration after completion of this procedure. If no change was observed in the reading, replace the electrode. If a change occurred but the unit still will not calibrate, repeat procedure as many times as necessary.

pH and ORP Electrode Cleaning Procedure

1. Remove the pH electrode from the system.
2. Spray with water and/or detergent, using a soft brush to dislodge any fouling.
3. Visually inspect the electrode for signs of damage.
4. Calibrate the electrode while it is in a known solution.

Slow response or non-reproducible measurements are signs that the electrode has become coated or clogged. The pH glass is susceptible to mounting by many substances. The speed of response, normally 95% of the reading in less than 10 seconds, is dramatically degraded when the pH glass is coated.

To restore the speed of response for a pH electrode, clean the bulb with a high-quality detergent, methyl alcohol or other suitable solvent using a Q-tip. Rinse well with distilled water and retest. If the electrode now responds, but erratically, soak the sensor in 0.1 Molar HCl for 5 minutes. Remove and rinse with water and place in 0.1 Molar NaOH for 5 minutes. Remove, rinse again, and then place the sensor in pH 4. buffer for 10 minutes before use.

VIII. Advantage Controls' Product Warranty

Advantage Controls warrants control systems of its manufacture to be free of defects in material or workmanship. Liability under this policy extends for 24 months from the date of installation. Liability is limited to repair or replacement of any failed equipment or part proven defective in material or workmanship upon manufacturer's examination. Removal and installation costs are not included under this warranty. Manufacturer's liability shall never exceed the selling price of equipment or part in question.

Advantage disclaims all liability for damage by its products caused by improper installation, maintenance, use or attempts to operate products beyond their intended functionality, intentionally or otherwise, or any unauthorized repair. Advantage is not responsible for damages, injuries or expenses incurred through the use of its products.

The above warranty is in lieu of other warranties, either expressed or implied. No agent of ours is authorized to provide any warranty other than the above.

30 Day Billing Memo Policy

Advantage Controls maintains a unique factory exchange program to ensure uninterrupted service with minimum downtime. If your controller malfunctions, call 1-918-686-6211, provide our technician with Model and Serial Number information. If they are unable to diagnose and solve your problem over the phone, a fully warranted replacement will be shipped, usually within 48 hours, on a 30-Day Billing Memo.

This service requires a purchase order, and the replacement is billed to your regular account for payment.

The replacement will be billed at the current list price for that model less any applicable resale discount. Upon return of your old panel, credit will be issued to your account at either 100% if your unit is in warranty or at 50% if your unit was out of warranty. The exchange covers only the panel. Electrode and enclosure are not included.

FCC Warning

This device complies with part 15 of the FCC Rules. Operation is subject to the following two conditions: (1) This device may not cause harmful interference, and (2) this device must accept any interference received, including interference that may cause undesired operation. See 47 CFR Sec. 15.19(3).

Common boiler blowdown valve connections

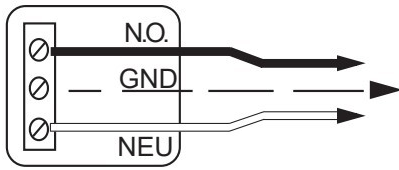

SOLENOID VALVES

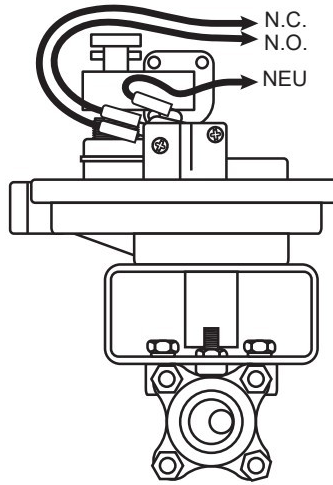
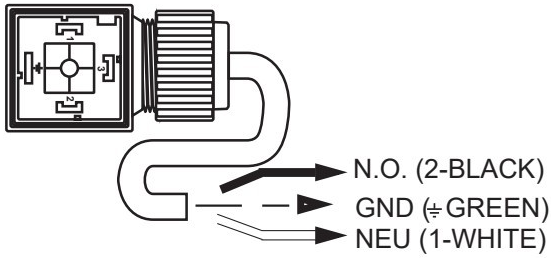

MBWB MOTORIZED VALVE

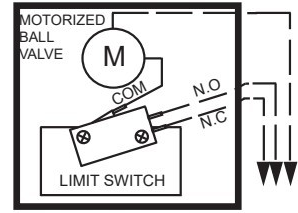

MBWB TOP VIEW

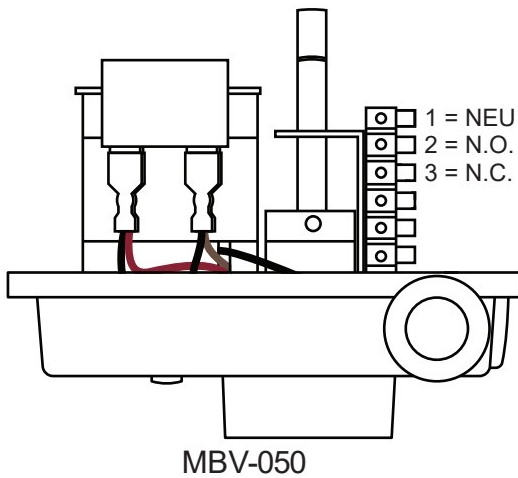

MBV-050

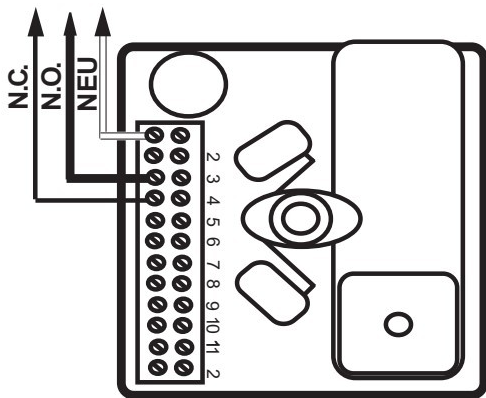

MBWA 1075

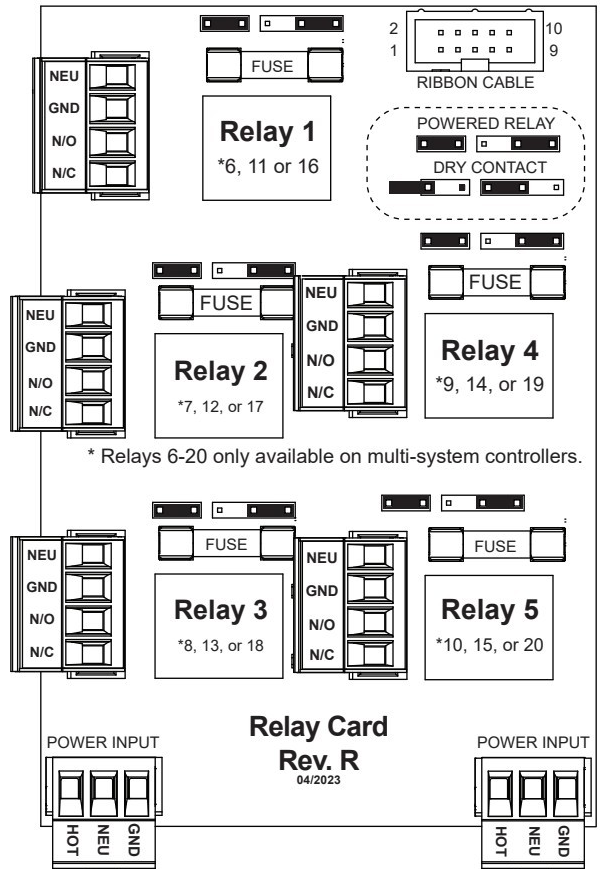

MegaTron mA Input Sensor Wiring

Note: mA input cards have the XT's +12 and -12 VDC on the middle connector voltage connections unless the 24 VDC accessory option has been selected or the card has been reconfigured for isolated power and an external 24 VDC landed.

Common 2 Wire Loop Transmitters

- Pressure
- Temperature
- Level (Echopod)

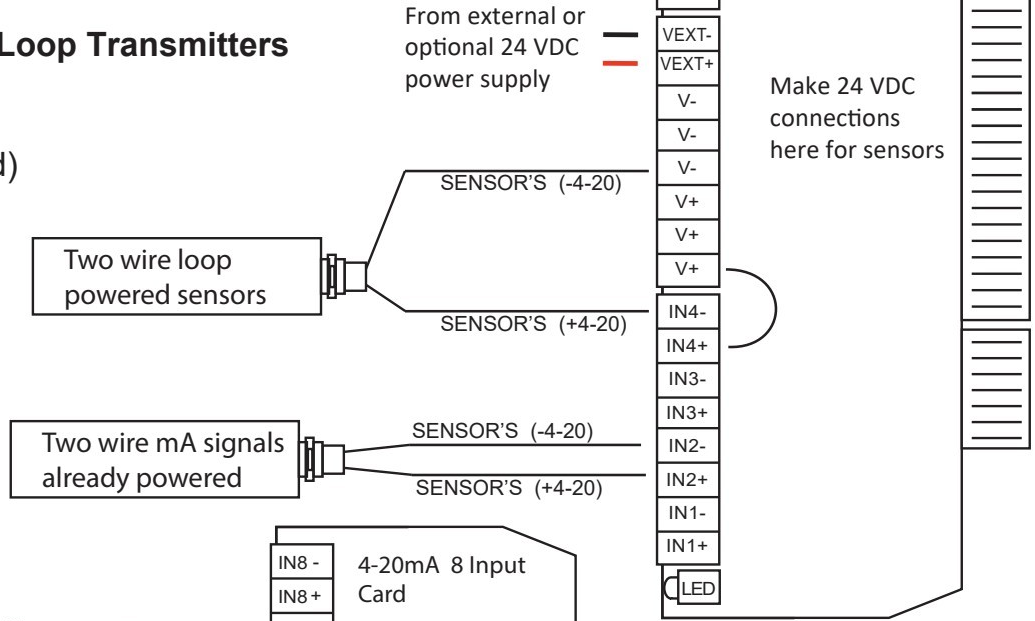

Common 4 Wire Sensors

XCITE PTSA

- Red V+
- Black V-
- Yellow mA+
- Orange mA-

LD2 PTSA

- Red V+
- Black V-
- Orange mA+
- Brown mA-

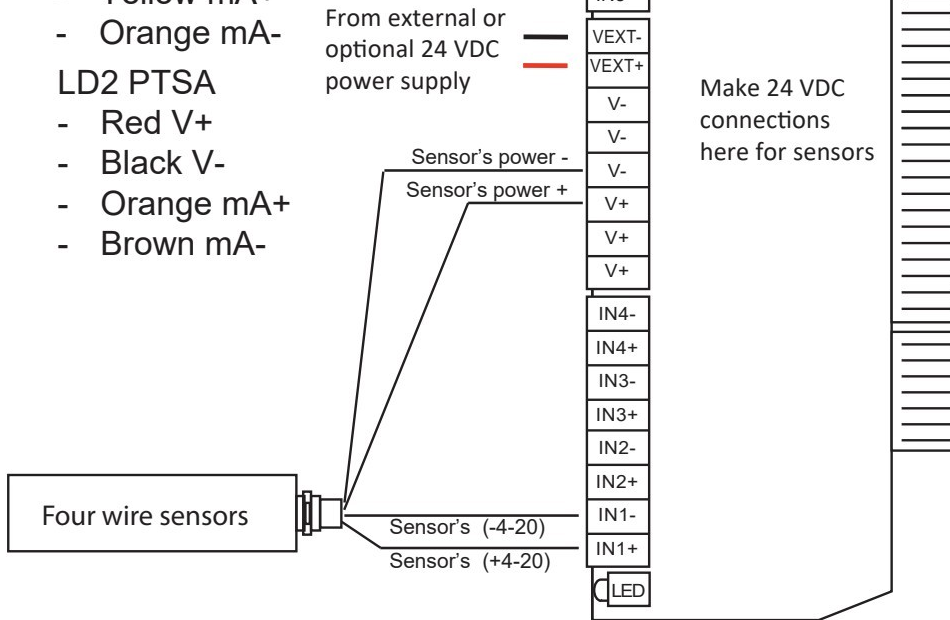

MegaTron XT wiring to Pyxis Sensors

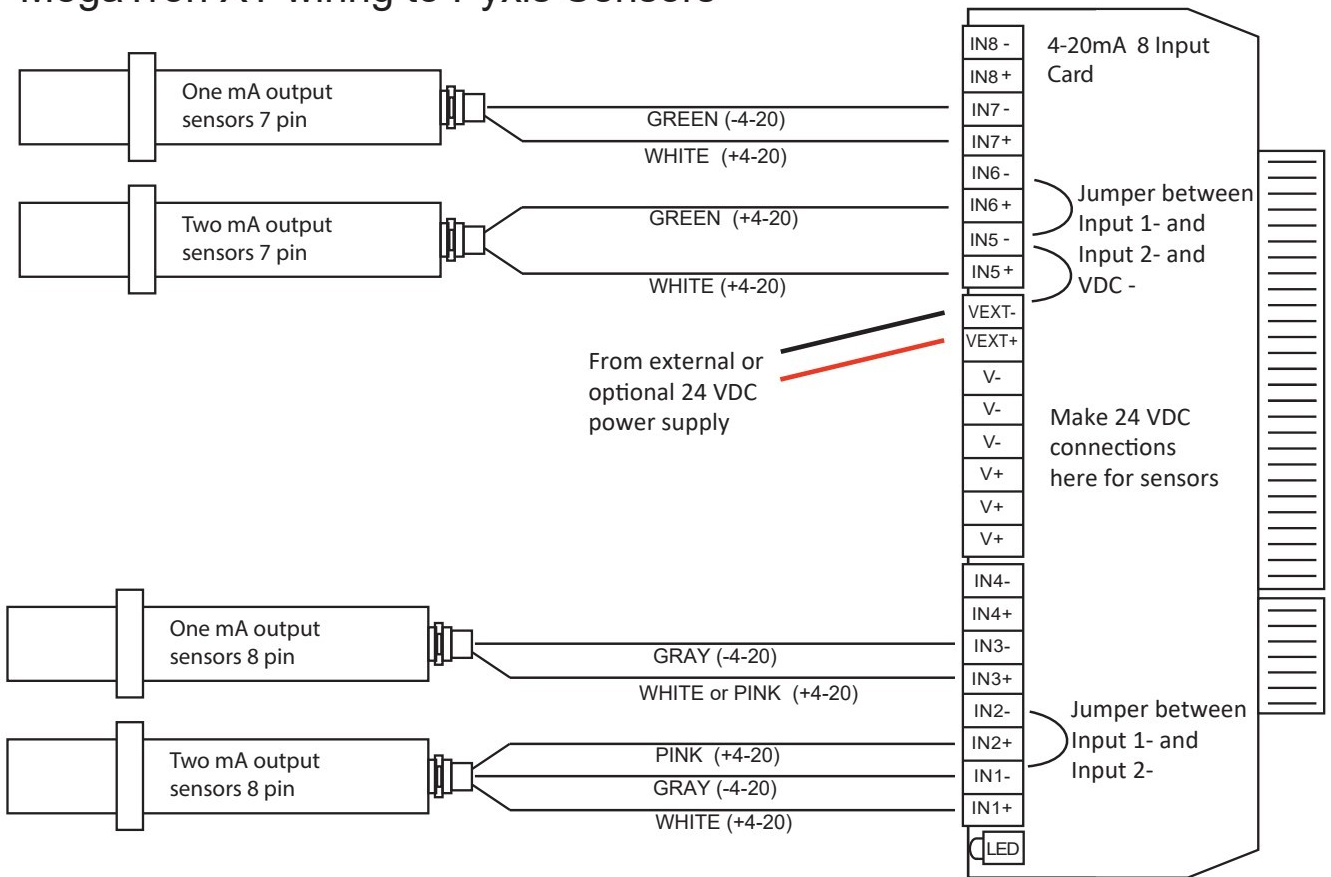

Controller Wiring for 8 Pin Cable Sensors

Wire Color	pH STA-710	ORP STA-711	pH & ORP STA-712	Conductivity STA-724	DO 772T	Turbidity LTA-632	Low Turb LTA-739
Red	24 VDC +	24 VDC +	24 VDC +	24 VDC +	24 VDC +	24 VDC +	24 VDC +
Brown	VDC - gnd	VDC - gnd	VDC - gnd	VDC - gnd	VDC - gnd	VDC - gnd	VDC - gnd
White	4-20mA+	Not used	pH 4-20mA+	Cond 4-20mA+	DO 4-20mA+	4-20mA+	4-20mA+
Pink	Not used	4-20mA+	ORP 4-20mA+	Temp 4-20mA+	Temp 4-20mA+	Not used	Not used
Gray*	4-20mA -	4-20mA -	4-20mA -	4-20mA -	4-20mA -	4-20mA -	4-20mA -
Blue	RS-485 A	RS-485 A	RS-485 A	RS-485 A	RS-485 A	RS-485 A	RS-485 A
Yellow	RS-485 B	RS-485 B	RS-485 B	RS-485 B	RS-485 B	RS-485 B	RS-485 B
Green	Not used	Not used	Not used	Not used	Not used	Not used	Not used

More 8 Pin Cable Sensors

Wire Color	FCL, CLO ₂ , Bromine, Sulfite STA-FCL,CLO,BRO,SUL
Red	24 VDC +
Brown	VDC - gnd
White	Oxidizer 4-20mA+
Pink	pH 4-20mA+
Gray*	4-20mA -
Blue	RS-485 A
Yellow	RS-485 B
Green	Not used

Controller Wiring for 7 Pin Cable Sensors

Wire Color	PTSA STA-500	Turbidity STA-730B	DO STA-773
Red	24 VDC +	24 VDC +	24 VDC +
Black	VDC - gnd	VDC - gnd	VDC - gnd
Green	4-20mA -	4-20mA -	4-20mA -
White	4-20mA+	4-20mA+	4-20mA+
Blue	RS-485 A	RS-485 A	RS-485 A
Yellow	RS-485 B	RS-485 B	RS-485 B
Silver	Not used	Not used	Not used

*Internally connected to power ground

MegaTron wiring for Autotrol Turbine Meters

1" METER = 65 PULSES / GALLON

2" METER = 15 PULSES / GALLON

Note: Use 22 AWG (.76mm) twisted pair shielded wire for all of these low voltage signal connections.

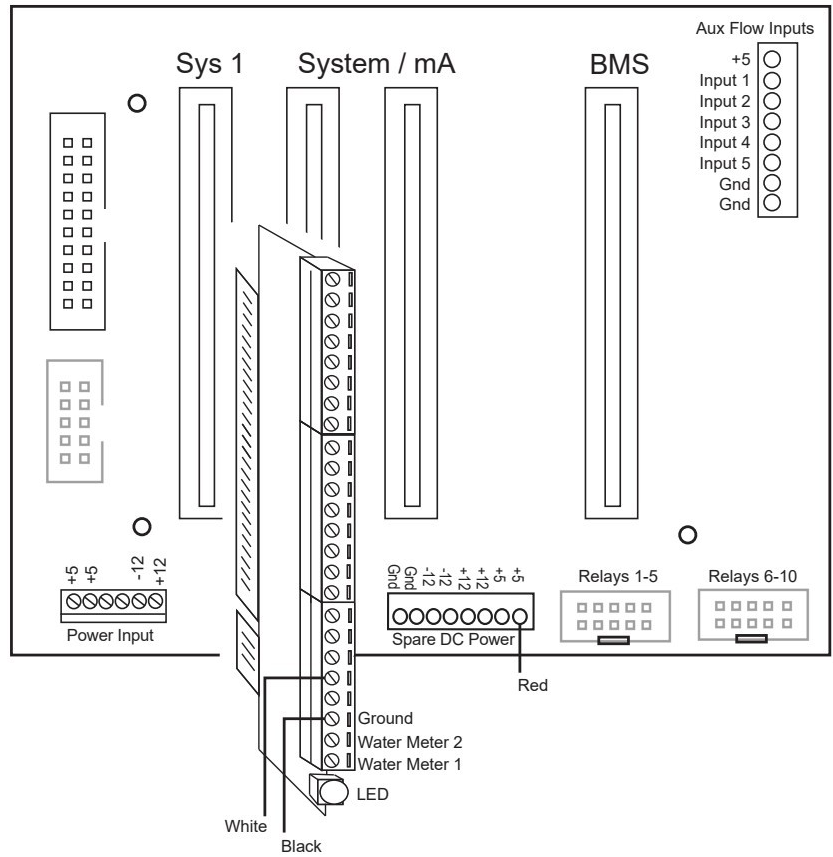

CABLE-7P-2A

Wiring a Nano-M to a
MegaTronXT, or
*Other Building
Management System

Note: Refer to full manual for
additional information

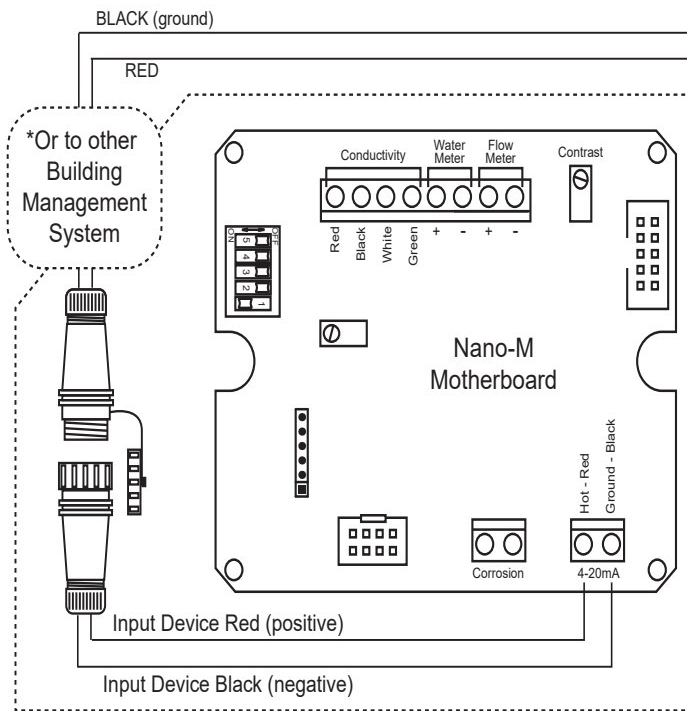
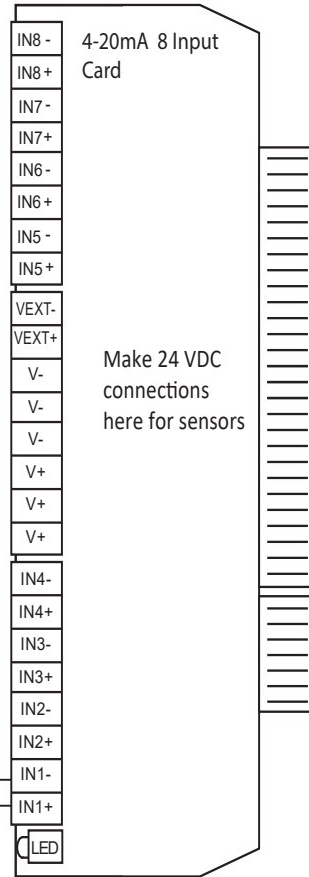

Get the Advantage in Water Treatment Equipment

Advantage Controls can give you the *Advantage* in products, knowledge, and support for all of your water treatment equipment needs.

- Cooling Tower Controllers
- Boiler Blow Down Controllers
- Blow Down Valve Packages
- Solenoid Valves
- Water Meters
- Chemical Metering Pumps
- Corrosion Coupon Racks
- Chemical Solution Tanks
- Solid Feed Systems
- Feed Timers
- Filter Equipment
- Glycol Feed Systems
- Pre-Fabricated Systems

