

NanoTron-M Corrosion Monitor and Control

*Installation
Maintenance
Repair
Manual*

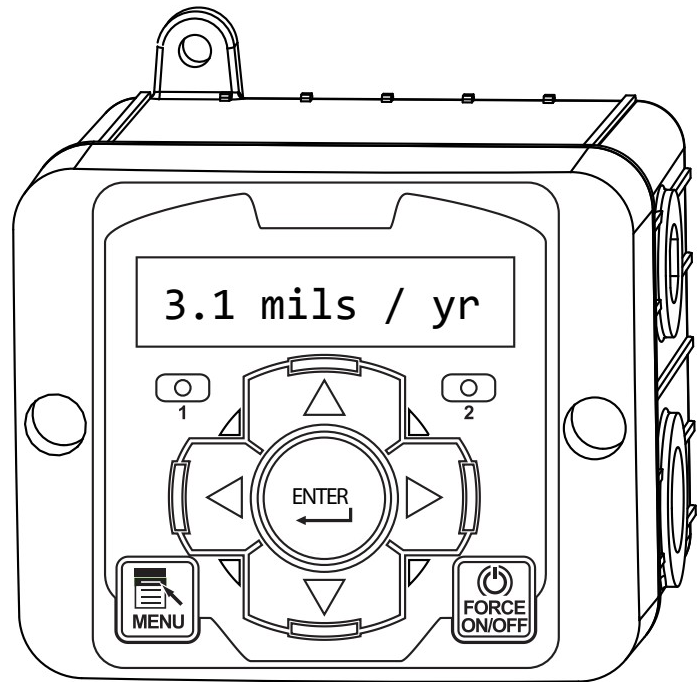

Advantage Europe

The European branch of Advantage Controls

Support: info@advantage-eu.com

Website: www.advantage-eu.com

*Vorsterweg 26
3980 Tessenderlo-Ham*

Belgium

08/2017

Table of Contents

Contents	Page
Quick Start Guide	3
I. Introduction.....	4
II. Description.....	4
Corrosion Rate Measurement	4
III. Controller Installation	
Electrical Wiring.....	4
Logic and Relay Cards	5
Controller Mounting Instructions.....	5
IV. Sensor Installation	
A. Probe and Tee Installation Guidelines.....	5
B. Probe Tip Handling.....	6
C. Probe Tip Installation Guidelines	6
D. Acclimation Period	6
E. Adjusting Dwell Time.....	7
V. Front Panel Description.....	7
VI. System Operation Overview.....	8
Description of Menus.....	8
VII. Nano-M0 Menu Map.....	9
Menu Navigation.....	9
VIII. Nano-M02 Menu Map.....	9
Menu Navigation.....	9
IX. Probe Tip Maintenance.....	11
X. Warranty & 30 Day Billing Memo Policy	11

Quick Start Guide

1. Ensure that the corrosion test loop abides by all guidelines given in Section IV and that the acclimation period has elapsed for the collection of valid, reproducible results.
2. Refer to sections V, VI and VII to become familiar with the front panel and menu structure of the Nano-M Corrosion Monitor.
3. Obtain a conductivity reading of the water in the corrosion loop.
4. Press the Menu button and use the down arrow to scroll through the Menu screen until you see the title "Conductivity". Press the Enter button. Input the conductivity value obtained in Step 3 into the field using the direction arrows and press Enter to confirm the value.
5. Press the Up arrow to scroll to the Dwell Time Menu, press the Enter button, and use the up and down directional arrows to choose the rate of time (fractions of one minute or whole minutes) at which samples are processed by the Nano-M. Dwell times of 6:00 to 10:00 are optimal for valid corrosion rate monitoring.
6. Press the Up arrow to scroll to the Probe Tip Type menu, press Enter, use the up and down directional arrows to choose the metal or metal alloy that corresponds to the probe tips that have been installed onto the corrosion probe, press Enter to confirm your selection.
7. Press the Down arrow to scroll to the Output Type menu, press Enter, use the up and down directional arrows to select your output signal type, press Enter to confirm your choice.
8. Press the Down arrow to scroll to the Output Scale menu, press Enter. Press Enter once again to access the Scale Low menu, this number represents the lowest value of the corrosion rate as represented by the analog output type, press Enter to confirm your selection.
9. Press the Down arrow to scroll to the Scale High menu, this number represents the highest value of the corrosion rate as represented by the analog output type, press Enter to confirm your selection.
10. Press the menu button to exit to the Run Screen and wait for the corrosion rate to be calculated and displayed.

I. Introduction

NANO-M controllers are microprocessor based menu driven units for monitoring corrosion rates in aqueous environments. All settings are entered into the controller through a simple front panel keypad which includes relay test keys and LED indicating lights.

Model Numbering

NanoTron units have several base system control functions and unit optional features. Your unit may be supplied with one or more of the features described in this manual. To determine what features apply to your unit check the model number label located on the controller enclosure.

Corrosion Only

- M0** - Corrosion monitor with no sensor body
- M01** - Corrosion monitor with PVC quick release probe body and ¾" tee; 140 PSI @ 75°F
- M02** - Corrosion monitor with 1" SS threaded probe body; 200 PSI @ 200°F

Corrosion and Pitting

- M20** - Corrosion and pitting monitor with no sensor
- M21** - Corrosion and pitting monitor with PVC quick release
- M22** - Corrosion and pitting monitor with 1" SS threaded probe

Options

Your unit may be supplied with one or more options listed at the end of the model number (i.e. **NANO-M0-AE3**). This list represents our most popular options. For a complete list of options, consult the factory.

- A** = 120 VAC conduit connections
- A3** = Liquid tights only with CE mark, 240 VAC
- A5** = USA power cord and no relay cord
- K** = Prewired cable for mA output with external connector
- W** = Larger enclosure with clear lockable cover

II. Description

NANO-M units are designed to monitor the linear polarization resistance (LPR) between two metal tips. Relative corrosion rates are calculated by measuring polarization voltage and current. All units include:

- Set point relay control with differential, high and low alarm.
- Conductivity variable manual input.
- Scalable 4-20mA output of corrosion rate of the 00.00-99.99 mils per year reading.
- A "force on" timer that allows for manual activation of the relay for a user defined amount of time.

Corrosion Rate Measurement

The linear polarization rate (LPR) is a relative corrosion rates calculated by measuring polarization voltage and current between two metal coupons. The NANO-M converts LPR to an annual rate of metal loss assuming linear constants to display a corrosion rate in mils per year (mpy) where 1 mil =0.001 inch.

NANO-M units should only be used in conductive fluids like cooling towers, chillers, boilers, waste water and potable water systems.

For more information detailing the LPR theory in measuring corrosion rates refer to ASTM and NACE publications.

III. Controller Installation

Electrical Wiring

The controller has internal regulated power supply options for 115 VAC or 240 VAC on the incoming wiring. Output relay is protected with a replaceable fuse. Relay output voltage will equal the incoming line voltage.

Prewired units are supplied with a 16 AWG cable with a 3-wire grounded USA 115 volt plug for incoming power and 18 AWG 3-wire grounded receptacle cord for the control relay output. Conduit units are supplied with liquid tights and adaptors for easy hard wiring to supplied connectors.

NOTE: Liquid tight fittings and some labeled signal leads are provided for signal (low voltage) connections, such as water meter inputs.



WARNINGS

1. The controller should be connected to its own isolated circuit breaker, and for best results, the ground should be a true earth ground, not shared. Wiring must be done according to all applicable local codes.
2. Power (line voltage) must be disconnected while making any connections. If power is supplied to the unit, line voltage will be present on the relay cards.
3. Low voltage signal wires (probes, flow switch, water meter, etc.) should never be run in conduit with high voltage wires.
4. Sensor cable can be extended up to 100 feet using single twisted pair, shielded cable 2 x AWG 22. Connect shield to controller ground and nothing a sensor end.

Logic and Relay Cards

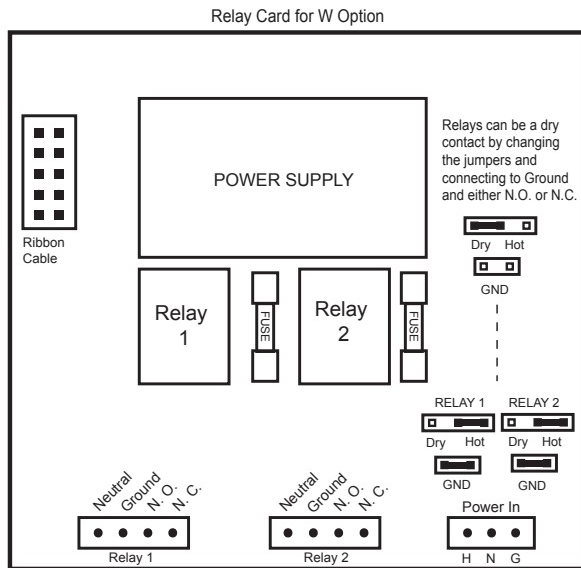
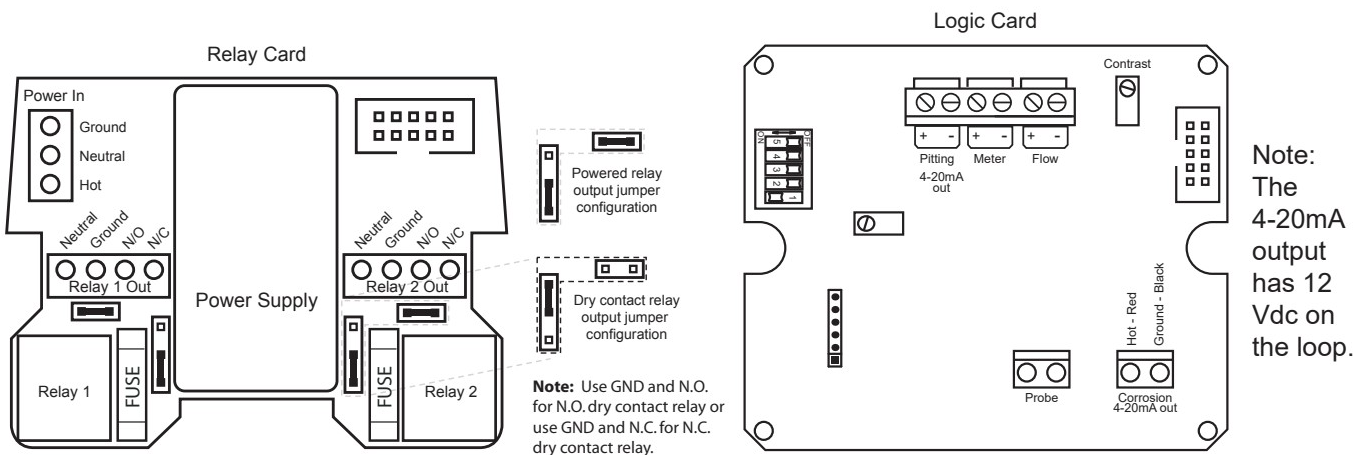

Controller Mounting Instructions

Select a mounting location that provides the operator easy access to the unit and a clear view of the controls through the cover of the controller. The unit should be located convenient to grounded electrical connections, the required sample line plumbing, and installed on a stable vertical surface.

- ! WARNING:**
Avoid locations that expose the controller to direct sunlight, vapors, vibration, liquid spills or extreme temperatures; less than 0°F (-17.8°C) or greater than 120°F (50°C). EMI electromagnetic interference from radio transmissions and electric motors can also cause damage or interference and should be avoided.

IV. Sensor Installation

A. Probe and Tee Installation Guidelines

- Nano-M units must only be used in conductive fluids such as those found in cooling towers, chillers, boilers, waste and potable water systems.
- A constant flow rate at a minimum of 1.6 gallons per minute (6.1 liters per minute) must exist within the corrosion monitoring loop.
- Do not install corrosion probe tees into the hottest part of a cooling loop. Corrosion rates from the hottest point may be higher than average.
- Seasonal variations can alter corrosion rates. Comparison testing is recommended to calculate the percentage of error due to weather changes in regards to corrosion rates.

- ! Coupon sensor should be installed with flow coming into the coupon tips.**

The inlet to the corrosion probe tee must have at minimum eight inches of straight 3/4" rigid pipe. No other loop components can be installed in this section of pipe immediately before the corrosion probe tee; this includes measurement probes, elbow fittings, or tee fittings. Any adapters or pipe size changes must occur prior to this eight inch section of pipe.

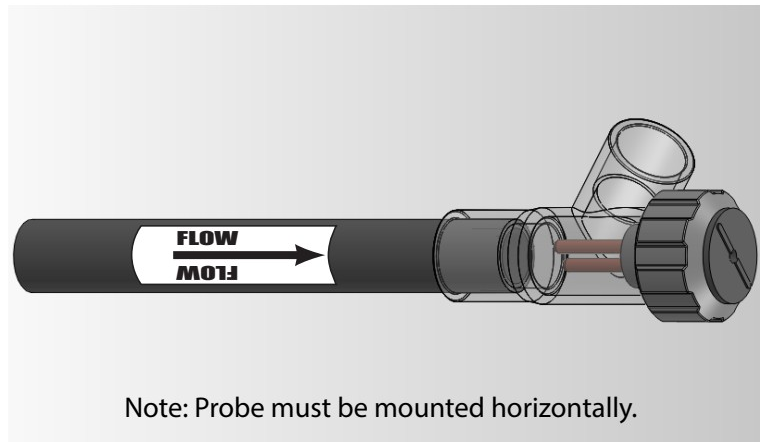

Typical Installation with Flow Traveling Up Plumbing into Probe Tips

B. Probe Tip Handling

Do not handle probe tips with bare hands. Oil, dirt, and other contaminants can foul the probe tips and cause measurement errors. The use of latex or vinyl gloves is recommended when installing or replacing probe tips.

C. Probe Tip Installation Guidelines

- Probe tips that are not treated with an inhibitor will initially corrode at high rates.
- Treating probe tips with high concentrations of inhibitor may lead to invalid corrosion rates that do not accurately reflect loop conditions.
- Scaled probe tips will produce corrosion rates that are invalid.
- Low pH loop conditions will increase mild steel corrosion rates.
- Conductivity rates and corrosion rates are interrelated. The conductivity value should be kept current in the Nano-M in the Conductivity Menu. A stable conductivity rate in the corrosion loop is recommended for the most valid corrosion rates.
- There must be no presence of oil in the corrosion loop. The presence of oil will lead to inaccurate and invalid corrosion rates.
- Do not use a hand tool to tighten the probe tip to the metal stud, probe tips are to be hand-tightened only.

Using gloves, screw one metal probe tip onto the threaded metal stud that protrudes from the corrosion probe body. Ensure that the probe tip is fully seated onto the metal stud and that it is touching the body of the corrosion probe.

The corrosion probe will need to be positioned in the corrosion tee so that the probe tips are perpendicular to the exit flow. See illustration in section IV.

D. Acclimation Period

After installing the corrosion probe into the corrosion loop it is best to allow the probe tips at least 48 hours to acclimate to the unique conditions of the loop. Readings taken before or during the acclimation period are generally regarded as invalid and can not be trusted as accurate representations of the corrosion rate.

E. Adjusting Dwell Time

Dwell time specifies the duration of time that is allocated for proper sampling and processing of the signals that are applied at the corrosion probe tips. The default dwell time is ten minutes per probe tip, meaning that once every twenty minutes a corrosion reading will be displayed by the Nano-M. The dwell time is configurable from 0:30 seconds to 20:00 minutes. The dwell time can be adjusted using the up and down arrow keys and pressing Enter to confirm a dwell time setting. In case of erratic corrosion rate readings, an optimum dwell time setting can be configured for a given system.

To configure the dwell time correctly, follow the procedure outlined below. Refer to Menu Map in Sec. VII.

1. Press the menu button to enter the main menu.
2. Use the up and down direction arrows to navigate to the Dwell time menu.
3. Press Enter to display the dwell time(MM:SS) selection menu.
4. Use the up and down direction arrows to navigate to the 20:00 option.
5. Press the Enter button to confirm this dwell time.
6. Use the up and down direction arrows to navigate to the Conductivity menu.
7. Press enter to edit the value of the conductivity.
8. Use the the left,right,up, and down direction arrows to input the conductivity value.
9. Press Enter to update the value of the Conductivity menu to the most current conductivity measurement available.
10. Press the Menu key and wait 40 to 50 minutes for the Nano-M to display a corrosion rate reading.
11. Repeat the above process reducing the dwell time by five minute increments until the corrosion rate readings have stabilized.

V. Front Panel Description

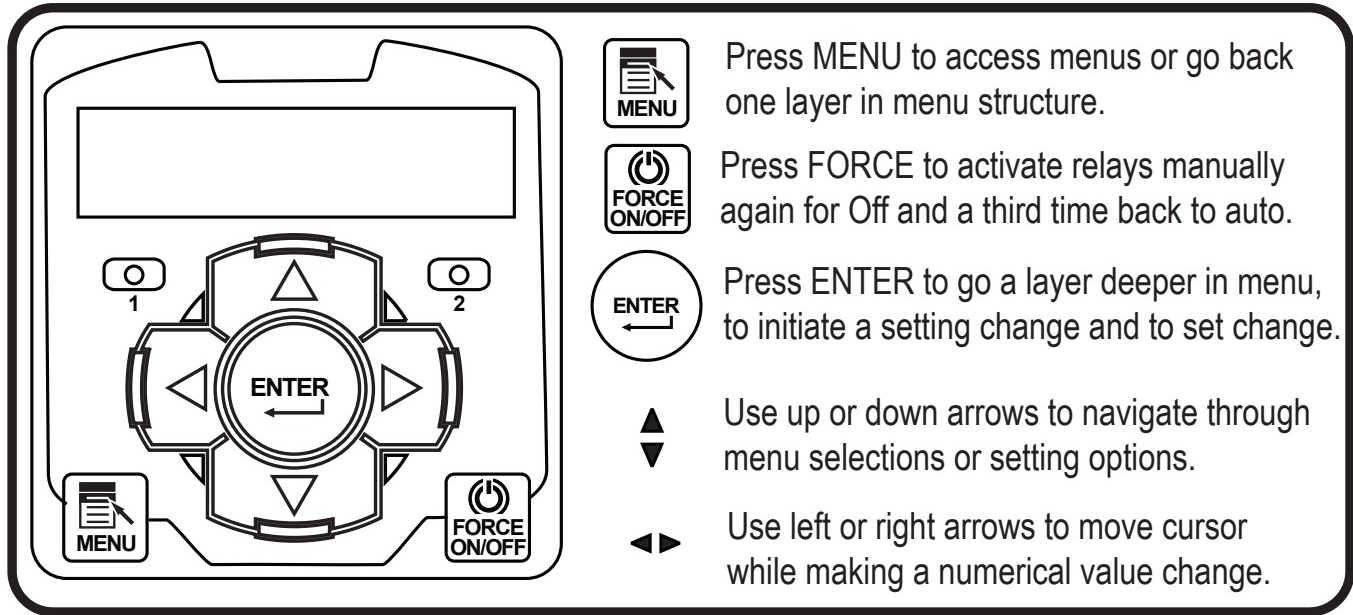

VI. System Operation Overview

Description of Menus

NanoTron controllers have three modes of operation, Run, Menu and Force. All menus are circular. Pressing the DOWN key will display the next line of information on the display.

Run - This mode is for normal operation. The control relays will only be automatically active in this mode. In the Run mode, the display will read system values. If an alarm is present, the display flashes with the alarm status.

The Run menu will display values such as Mils / yr (00.00-99.99) and other values depending upon the features present on the unit. The unit will automatically return to the Run mode if no keys are pressed for three minutes.

Menu - This mode is used to make adjustments to settings and readings on the controller. To access the Menu mode from the run screen, press the Menu key. Use the up or down arrow to scroll through the various menus. When you want to access a specific menu, press the Enter key. Once you have entered a sub-menu you will be able to step through that menu's options with the down arrow key.

Force - The relay may be forced on or off for a user defined amount of time. Press the Force button to access selections for amount of force on time, to force on or off or to go back to automatic. Relay activity will go back to automatic operation after force time has expired.

VII. Menu Map

NANO-M0 Models

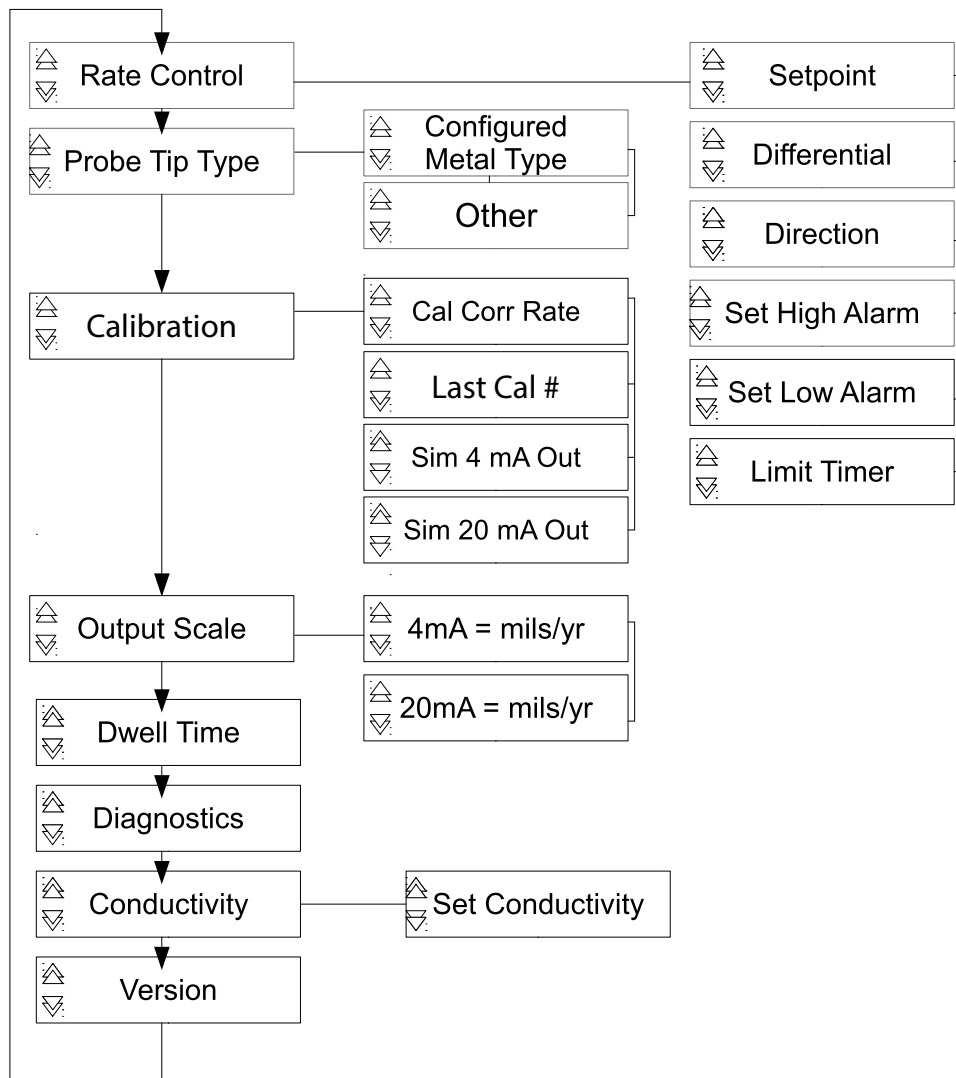

Menu Navigation

1. Rate Control

Setpoint: The user specified corrosion rate reading at which the control relay will be turned on.

Differential: The user specified amount the reading must change before the relay is turned off.

Direction: The direction setting allows the user to select a rising or falling setpoint to indicate whether the control relay activates when the reading goes above or below the setpoint.

Set High Alarm: The user specified corrosion reading that will activate the High Alarm notification. Notification is on screen and a dry contact relay.

Set Low Alarm: The user specified corrosion reading that will activate the High Alarm notification. Notification is on screen and a dry contact relay.

Limit Timer: Prevents the control relay from being active for longer than a programmable amount of time (HH:MM). If the control relay has not automatically turned off before the limit time is reached, the limit timer will disable the control relay. A setting of 00:00 disables the timer.

VIII. Menu Map

NANO-M02 Models

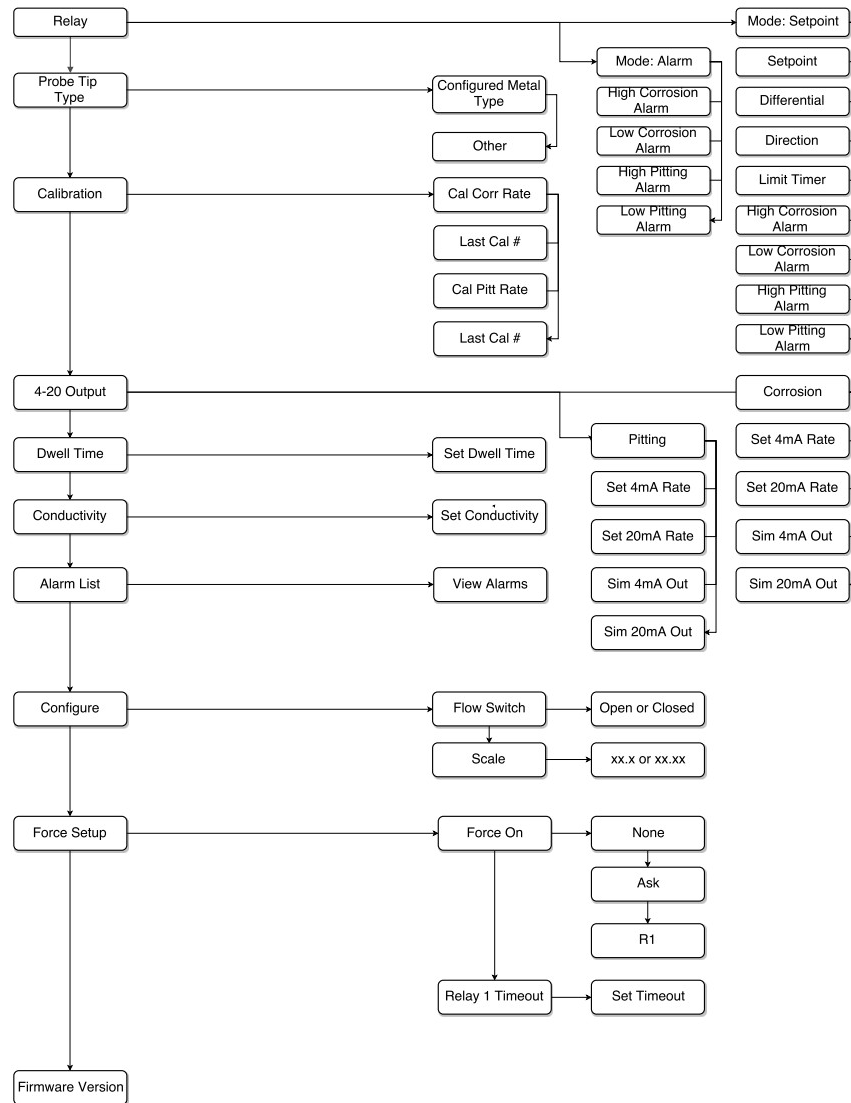

Menu Navigation

1. Rate Control

Setpoint: The user specified corrosion rate reading at which the control relay will be turned on.

Differential: The user specified amount the reading must change before the relay is turned off.

Direction: The direction setting allows the user to select a rising or falling setpoint to indicate whether the control relay activates when the reading goes above or below the setpoint.

Set High Alarm: The user specified corrosion reading that will activate the High Alarm notification. Notification is on screen and a dry contact relay.

Set Low Alarm: The user specified corrosion reading that will activate the High Alarm notification. Notification is on screen and a dry contact relay.

Limit Timer: Prevents the control relay from being active for longer than a programmable amount of time (HH:MM). If the control relay has not automatically turned off before the limit time is reached, the limit timer will disable the control relay. A setting of 00:00 disables the timer.

2. Probe Tip Type: Configured Metal Type: Allows user to select one of five pre-configured metal types: Mild Steel, Copper, Admiralty Brass, Cupro-Nickel, and Aluminum 7075.

Other: If using a probe tip type not in the pre-configured list a user-defined multiplier must be specified (00 to 9.99).

Multiplier	Material	UNS Identifier
0.89	AISI 304 Stainless Steel	S30400
0.90	AISI 316 Stainless Steel	S31600
0.90	AISI 316L Stainless Steel	S31603
1.00	AISI 4130 Steel	G41300
0.94	Aluminum 1100 (Common)	A91100
0.88	Aluminum 2024	A92024
1.62	Aluminum Brass Arsenical	C68700
1.48	Aluminum Silicon Bronze	C64200
1.67	Arsenical Admiralty Copper	C44300
1.00	Mild Steel	K03005
2.00	Copper 110 (Common)	C11000
1.80	Copper nickel 10%	C70600
1.50	Copper nickel 30%	C71500
2.57	Lead (Common)	L50045
1.68	Phosphorized Admiralty Copper	C44500
0.75	Titanium (Grade 1, 2, 5, 7, 9, 12)	R50400
1.29	Zinc (Grade 1A, 1, 2, 3, and 5)	Z17001

3. Calibrate

Cal Corr Rate: Allows the user to adjust the displayed corrosion rate. Enter a value of 00:00 to erase any calibrations and return to factory default.

Last Cal #: Displays the corrosion rate value used when the system was last calibrated. "LastCal#=00.00" is displayed when the factory calibration is being used.

Sim 4mA Out: While in this screen the unit will produce its 4mA output. The output can be trimmed with the up or down arrows to match an external reading check.

Sim 20mA Out: While in this screen the unit will produce its 20mA output. The output can be trimmed with the up or down arrows to match an external reading check.

4. Output Scale

4mA = mil/yr: The user specified corrosion rate at which a 4mA output signal will be generated.

20mA = mil/yr: The user specified corrosion rate at which a 20mA output signal will be generated.

Note: These settings allow the 4-20mA signal (with 12 Vdc on the loop) to be set to a proportional range defined by the user instead of the full (00.00-99.99) scale. Example: 4mA could be at 0.0 mil/yr and 20mA at 3.0 mil/yr with the mA output signal proportionally between 4 & 20mA the same as the reading is between 0.0 and 3.0

5. Dwell Time: Specifies the duration of time that is allocated for proper sampling and processing of the signals that are applied at the corrosion probe tips. The default dwell time is ten minutes per probe tip, meaning that once every twenty minutes a corrosion reading will be displayed by the unit.

6. Diagnostics: Displays voltage and current applied to the probe tips during the dwell time. This is for troubleshooting purposes only and can be ignored in normal operating.

7. Conductivity: The user specified conductivity reading of the system.

IX. Probe Tip Maintenance

A proper maintenance schedule must be established to consistently obtain valid corrosion rates. Probe tips will foul and corrode at varying rates due to environmental factors that exist within a corrosion loop. When heavily fouled or corroded probe tips are discovered in the corrosion loop it is best to discard the tips. If the probe tips are lightly fouled or corroded, use the following steps.

1. Remove the corrosion probe from the loop, make sure to isolate the corrosion loop.
2. While wearing gloves, unscrew both of the probe tips from the threaded metal studs on the corrosion probe. Do not remove the gloves at any time during the cleaning procedure.
3. Place the probes onto a clean surface and gather the materials necessary to properly clean the tips, isopropyl alcohol and sandpaper with a grit between 220 and 400.
4. Choose one probe tip and hold it in between the thumb and index finger of one hand. Use the other hand to gently and evenly sand off the fouled probe tip while rolling it in between the index finger and thumb of the holding hand. Continue to sand the probe tip until it is uniformly clean.
5. Apply alcohol to a cotton swab, or paper towel, and polish the probe tip.
6. Set the cleaned probe tip aside and repeat the process on the remaining probe tip.
7. Return both probe tips to the metal studs on the corrosion probe and hand tighten until they are securely seated to the corrosion probe body.
8. Install the probe into the corrosion loop in accordance to the procedure detailed in Section IV.

X. Manufacturer's Product Warranty

Advantage Controls warrants units of its manufacture to be free of defects in material or workmanship. Liability under this policy extends for 24 months from date of installation. Liability is limited to repair or replacement of any failed equipment or part proven defective in material or workmanship upon manufacturer's examination. Removal and installation costs are not included under this warranty. Manufacturer's liability shall never exceed the selling price of equipment or part in question. Advantage disclaims all liability for damage caused by its products by improper installation, maintenance, use or attempts to operate products beyond their intended functionality, intentionally or otherwise, or any unauthorized repair. Advantage is not responsible for damages, injuries or expense incurred through the use of its products. The above warranty is in lieu of other warranties, either expressed or implied. No agent of ours is authorized to provide any warranty other than the above.

30 Day Billing Memo Policy

Advantage Controls maintains a unique factory exchange program to ensure uninterrupted service with minimum downtime. If your unit malfunctions, call 1-800-743-7431, and provide our technician with Model and Serial Number information. If we are unable to diagnose and solve your problem over the phone, a fully warranted replacement unit will be shipped, usually within 48 hours, on a 30 Day Billing Memo. This service requires a purchase order and the replacement unit is billed to your regular account for payment. The replacement unit will be billed at current list price for that model less any applicable resale discount. Upon return of your old unit, credit will be issued to your account if the unit is in warranty. If the unit is out of warranty or the damage not covered, a partial credit will be applied based upon a prorated replacement price schedule dependent on the age of the unit. Any exchange covers only the controller or pump. Electrodes, liquid end components and other external accessories are not included.

FCC Warning

This equipment generates and uses radio frequency energy and if not installed and used properly, that is, in strict accordance with the manufacturer's instruction, may cause interference to radio communications. It has been type tested and found to comply with the limits for a class A computing device pursuant to subpart J of part 15 of FCC Rules, which are designed to provide reasonable protection against such interference when operated in a commercial or industrial environment. Operation of this equipment in a residential area is likely to cause interference in which case the user, at his own expense, will be required to take whatever measures necessary to correct the interference.

Get the Advantage in Water Treatment Equipment

Advantage Controls can give you the *Advantage* in products, knowledge and support on all of your water treatment equipment needs.

- Cooling Tower Controllers
- Boiler Blow Down Controllers
- Blow Down Valve Packages
- Solenoid Valves
- Water Meters
- Chemical Metering Pumps
- Corrosion Coupon Racks
- Chemical Solution Tanks
- Solid Feed Systems
- Feed Timers
- Filter Equipment
- Glycol Feed Systems
- Pre Fabricated Systems

